

Gruppe  
Group **A/B**

Testblatt nach Anhang J des Internationalen Automobil-Sportgesetzes

Homologation form in accordance with appendix J of the international sporting code

1 MARS 1986

Homologation gültig ab  
Homologation valid as from

in Gruppe  
in group

A

Foto A  
Photo A



Foto B  
Photo B



1. Definitionen  
Definitions

101. Hersteller  
Manufacturer

Volkswagen AG

102. Handelsbezeichnung — Typ und Modell  
Commercial name(s) — Type and model

19 Golf GTI 16 V

103. Gesamthubraum  
Cylinder capacity

1781,32

ccm

104. Art der Konstruktion  
Type of car construction

getrennt, Material des Chassis  
Separate, material of chassis

Stahlblech / steel

selbsttragend, Material der Karosserie  
Unitary construction

Stahlblech / steel

105. Anzahl der Volumina  
Number of volumes

2

106. Anzahl der Sitzplätze  
Number of places

5

Unterschrift und Stempel  
der Nationalen Sporthoheit  
Signature and stamp  
of national sporting authority

Unterschrift und Stempel  
der FIS  
Signature and stamp  
of F.I.S.A.

*[Signature]*  
FÉDÉRATION INTERNATIONALE  
DE L'AUTOMOBILE

Marke Volkswagen Modell Golf GTI 16 V Homologation Nr. A-5295  
Make \_\_\_\_\_ Mode: \_\_\_\_\_ Homologation Nr. \_\_\_\_\_  
Homologation Nr. \_\_\_\_\_

**2. Abmessungen — Gewichte**  
Dimensions — weights

202. Länge über alles 3987 mm  $\pm 1\%$   
Overall length
203. Breite über alles 1680 mm  $\pm 1\%$  Meßpunkt: Hinterradmitte / rear-axle centre  
Overall width Where measured
204. Karosseriebreite: a) Vorderradmitte 1676 mm  $\pm 1\%$   
Width of bodywork At front axle  
b) Hinterradmitte 1680 mm  $\pm 1\%$   
At rear axle
206. Radstand: a) Rechts 2475 mm  $\pm 1\%$  b) Links 2475 mm  $\pm 1\%$   
Wheelbase Right Left
209. Überhang: a) Vorne 807 mm  $\pm 1\%$  b) Hinten 705 mm  $\pm 1\%$   
Overhang Front Rear
210. Entfernung „G“ (Lenkrad-hintere Trennwand) 1596 mm  $\pm 1\%$   
Distance „G“ (steering wheel — rear bulkhead)

**3. Motor** (Für Kreiskolbenmotor siehe Artikel 335 auf Nachtragsblatt)  
Engine (In case of rotative engine, see Article 335 on complementary form)

301. Einbauort und Lage des Motors vorn quer / front transversal 150 to rear  
Location and position of the engine
303. Arbeitsverfahren viertakt Otto / 4 stroke  
Cycle
304. Aufladung nein / Typ /  
Supercharging yes/no: Type  
(Bei Aufladung siehe auch Artikel 334 auf Nachtragsblatt)  
(In case of supercharging see also Article 334 on complementary form)
305. Anzahl und Anordnung der Zylinder 4 in Reihe / 4 in-line  
Number and layout of the cylinders
306. Kühlsystem Flüssigkeit / liquid  
Cooling system
307. Hubraum: a) Pro Zylinder 445.33 ccm b) Gesamt 1781.32 ccm  
Cylinder capacity: a) Unitary Total  
c) Maximal zulässiger Hubraum\* 1807.8 ccm \* (Diese Angabe gilt nicht für Gruppe N)  
Maximum total allowed\* \* (This indication is not to be considered in Group N)

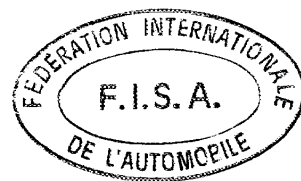

Marke Volkswagen

Modell Golf GTI 16 V

Homologation Nr. A-5295

312. Material des Zylinderblocks Gußeisen / cast iron  
Cylinder block material:

313. Laufbuchsen: a)  ja / nein c) Typ ./.  
Sleeves: yes/no Type

314. Bohrung 81,01 mm  
Bore

315. Maximal zulässige Bohrung 81,61 mm  
Maximum bore allowed (Diese Angabe gilt nicht für Gruppe N)  
(This indication is not be considered in Group N)

316. Hub 86,4 mm  
Stroke

318. Pleuel: a) Material Stahl / steel b) Art des Pleueifußes geteilt / two pieces  
Connecting rod: a) Material Big end type

c) Innerer Durchmesser des Pleueifußes (ohne Lager) 50,6 mm  $\pm 1\%$   
Interior diameter of the big end (without bearings)

d) Länge zwischen den Achsen 144 mm ( $\pm 0,1$  mm) e) Mindestgewicht 572  
Length between the axes Minimum weight

319. Kurbelwelle: a) Herstellungsart einteilig / one piece  
Crankshaft: type of manufacture

b) Material Stahl / steel  
Material

c)  gegossen  geschmiedet d) Anzahl der Kurbelwellen-Hauptlager 5  
moulded stamped Number of bearings

e) Art der Kurbelwellen-Hauptlager Gleitlager / smooth bearings  
Type of bearings

f) Durchmesser der Kurbelwellen-Hauptlager 54 mm  $\pm 0,2\%$   
Diameter of bearings

g) Material der Lagerdeckel Gußeisen / cast iron  
Bearing caps material

h) Mindestgewicht der Kurbelwelle (allein) 12.950  
Minimum weight of the bare crankshaft

320. Schwungrad: a) Material Stahl / steel  
Flywheel: Material

b) Mindestgewicht mit Anlaßzahnkranz 5.050  
Minimum weight of the flywheel with starter ring

321. Zylinderkopf: a) Anzahl der Zylinderköpfe 1 b) Material Aluminium  
Cylinderhead: Number of cylinderheads Material

323. Kraftstoffzufuhr durch Vergaser: a) Anzahl der Vergaser ./.  
Fuel feed by carburettor(s): Number of carburettors

b) Typ ./. c) Marke und Modell ./.  
Type Marke and model

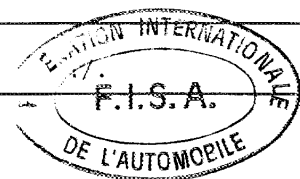

Marke Volkswagen Modell Golf GTI 16 V Homologation Nr. A-5295  
 Make Model Homologation Nr.

- d) Anzahl der Gemischdurchlässe je Vergaser ./.  
 Number of mixture passages per carburettor
- e) Maximaler Durchmesser der Gemischöffnung am Vergaserausgang ./. mm  
 Maximum diameter of the flange hole of the carburettor exit port
- f) Durchmesser des Lufttrichters am engsten Punkt ./. mm  
 Diameter of the venturi at the narrowest point

324. Kraftstoffzufuhr durch Einspritzung a) Hersteller Bosch  
 Fuel feed by injection: Manufacturer
- b) Modell des Einspritzsystems K-Jetronic  
 Model of injection system
- c) Art der Kraftstoffdosierung  mechanisch  elektronisch  hydraulisch  
 Kind of fuel measurement mechanical electrical hydraulic
- c1) Kolbenpumpe  ja /  nein c2) Luftvolumenmessung ja /  nein  
 Piston pump yes/no Measurement of air volume yes/no
- c3) Luftmassenmessung  ja /  nein c4) Luftgeschwindigkeitsmessung ja /  nein  
 Measurement of air mass yes/no Measurement of air speed yes/no
- c5) Luftdruckmessung  ja /  nein Welcher Druck wird zur Messung herangezogen?          bar  
 Measurement of air pressure yes/no Which pressure is taken for measurement?
- d) Abmessungen der Drosselklappe(n) oder der/des Schieber(s) ∅ 35 / 52 ± 0,25 mm  
 Effective dimensions of measure position in the throttle area
- e) Anzahl der effektiven Kraftstoffauslässe 5  
 Number of effective fuel outlets
- f) Lage der Einspritzventile  Saugrohr  Zylinderkopf  
 Position of injection valves Inlet manifold Cylinderhead
- g) Teile des Einspritzsystems, die zur Kraftstoffdosierung dienen: Gemischregler, Mengenteiler incl. /  
 Statement of fuel measuring parts of injection system: mixture control unit, metering valve incl.  
Luftvolumenmesser, Warmlaufregler, Einspritzventile incl. Leitungen, Kraftstoff-  
air flow meter, warm up valve, injection valve incl. fuel lines, fuel pump  
Thermozeitschalter / temperature time switch

325. Nockenwelle: a) Anzahl 2 b) Lage OHC  
 Camshaft: Number Location
- c) Art des Antriebs Zahnriemen / sprocket belt d) Anzahl der Lager pro Nockenwelle Einlaß: 5  
 Driving system Number of bearings for each shaft Auslaß: 6
- f) Art der Ventilbetätigung direkt / direct  
 Type of valve operation

326. Steuerung: e) Maximaler Ventilhub Einlaß 9,6 mm Auslaß 10,2 mm  
 Timing: Maximum valve lift Inlet Exhaust
- Mit einem Spiel von 0 mm  
 With clearance

327. Einlaß: a) Material des Ansaugkrümmers Aluminium  
 Inlet: Material of the manifold
- b) Anzahl der Ansaugkrümmerelemente 1 + 1 c) Anzahl der Ventile pro Zylinder 2  
 Number of manifold elements Number of valves per cylinder
- d) Maximaler Durchmesser der Ventile 32 mm e) Durchmesser des Ventilschafts 6,97 - 0,2 mm  
 Maximum diameter of the valves Diameter of the valve stem
- f) Länge des Ventils 95,8 ± 1,5 mm g) Art der Ventilsfeder Spiralfedern / helical sp  
 Length of the valve Type of valve springs

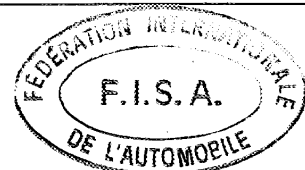

A - 5295

Marke Volkswagen Modell Golf GTI 16 V Homologation Nr. \_\_\_\_\_  
Make Model Homologation Nr.

328. Auslaß: a) Material des Auslaßkrümmers Grauguß / cast iron  
Exhaust: Material of the manifold  
b) Anzahl der Auslaßkrümmerelemente 1 d) Anzahl der Ventile pro Zylinder 2  
Number of manifold elements Number of valves per cylinder  
e) Maximaler Durchmesser der Ventile 28 mm f) Durchmesser des Ventilschafts 6,93 - 0,2 mm  
Maximum diameter of the valves Diameter of the valve stem  
g) Länge des Ventils 98,7 ± 1,5 mm h) Art der Ventilsfeder Spiralfeder/helical spring  
Length of the valve Type of valve springs

330. Zündanlage: a) Art Batterie  
Ignition system: Type  
b) Anzahl der Kerzen pro Zylinder 1 c) Anzahl der Verteiler 1  
Number of plugs per cylinder Number of distributors

333. Schmiersystem: a) Art Ölsumpfschmierung / b) Anzahl der Ölpumpen 1  
Lubrication system: Type wet sump Number of oil pumps

**4. Kraftstoffanlage**  
Fuel circuit

401. Tank: a) Anzahl 1 b) Lage Unter Kofferraumboden /  
Fuel tank: Number Location below floor pan  
c) Material PVC d) Maximaler Inhalt 55 Liter  
Material Maximum capacity litre

**5. Elektrische Ausrüstung**  
Electrical equipment

501. Batterie(n): a) Anzahl 1  
Batteries: Number

**6. Kraftübertragung**  
Drive

601. Antriebsräder  vorn  hinten  
driving wheels: front rear

602. Kupplung: b) Art der Betätigung mechanisch / mechanical  
Clutch: Drive system  
c) Anzahl der Scheiben 1  
Number of plates

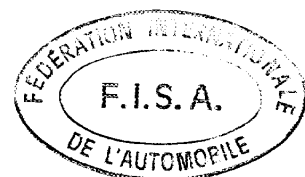

Marke Volkswagen  
 Make

Modell Golf GTI 16 V  
 Model

Homologation Nr. A-5295  
 Homologation Nr.

603. Getriebe: a) Lage im Motorraum / in engine compartment  
 Gear-box Location

b) Manuelles Getriebe, Marke VW c) Automatisches Getriebe, Marke /  
 „Manual“ make „Automatic“ make

d) Anordnung des Gangschalthebels auf Mittelunnel / on center tunnel  
 Location of the gear lever

e) Übersetzungen  
 Ratios

	Handschaltung Manual			Automatik Automatic			Zusätzl. Getriebe Additional GB		
	Über- setzungen ratio	Anzahl der Zähne number of teeth	synchro	Über- setzungen ratio	Anzahl der Zähne number of teeth	synchro	Über- setzungen ratio	Anzahl der Zähne number of teeth	synchro
1	3,455	38 : 11	x				2,727	30 : 11	x
2	2,118	36 : 17	x				2,063	33 : 16	x
3	1,444	39 : 27	x				1,684	32 : 19	x
4	1,129	35 : 31	x				1,429	30 : 21	x
5	0,912	31 : 34	x				1,261	29 : 23	x
Rück- wärts R	3,167	38 : 12					3,167	38 : 12	
Kon- stante Con- stant									

f) Schalt-Schema  
 Gear change gate

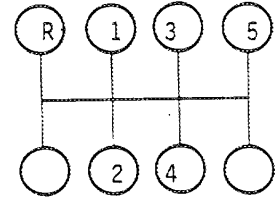
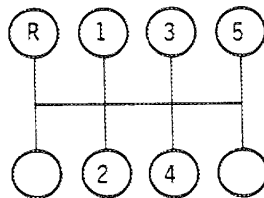

604. Schnellgang: a) Art ./.  
 Overdrive: Type

b) Übersetzung ./. c) Anzahl der Zähne ./.  
 Ratio Number of teeth

d) Vorwärtsgänge, zu denen der Schnellgang zugeschaltet werden kann ./.  
 Usuable with the following gears



Marke Volkswagen  
Make

Modell Golf GTI 16 V  
Model

Homologation Nr. A-5295  
Homologation Nr.

605. Antriebsachse  
Final drive

- a) Art des Achsantriebs  
Type of final drive
- b) Übersetzungsverhältnis  
Ratio
- c) Anzahl der Zähne  
Number of teeth
- d) Art des Sperrdifferentials  
(wenn vorhanden)  
Type of differential limitation  
(if provided)

Vorn Front	Hinten Rear
Stirnrad / crown-wheel	
3,667	
66 : 18	

e) Übersetzungsverhältnis des Verteilergetriebes ./.  
Ratio of the transfer box

606. Art der Gelenkwelle Gleichlaufgelenkwellen / constant velocity joint shafts  
Type of transmission shaft

7. Radaufhängung  
Suspension

701. Art der Radaufhängung: a) Vorn Einzelradaufhängung / independent wheels with lower wishbone  
Type of suspension Front  
b) Hinten Verbundlenkerachse / torsion beam axle  
Rear

702. Schraubenfedern: Vorn: ja / ~~nein~~ Front: yes/no Hinten: ja / ~~nein~~ Rear: yes/no  
Helicoidal springs

703. Blattfedern: Vorn: ~~ja~~ / nein Front: yes/no Hinten: ~~ja~~ / nein Rear: yes/no  
Leaf springs

704. Drehstab: Vorn: ~~ja~~ / nein Front: yes/no Hinten: ~~ja~~ / nein Rear: yes/no  
Torsion bar

705. Andere Arten der Radaufhängung: s. Bild / Zeichnung auf Seite 15  
Other type of suspension. See photo or drawing on page 15

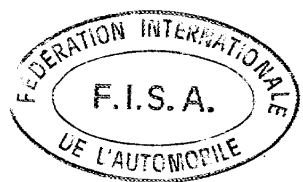

Marke Volkswagen  
Make

Modell Golf GTI 16 V  
Model

Homologation Nr. A-5295  
Homologation Nr.

707. Stoßdämpfer  
Shock absorbers

- a) Anzahl je Rad  
Number per wheel
- b) Art  
Type
- c) Funktionsprinzip  
Working principle

Vorn Front	Hinten Rear
<u>1</u>	<u>1</u>
<u>Teleskop / telescopic</u>	<u>Teleskop / telescopic</u>
<u>hydraulisch / hydraulic</u>	<u>hydraulisch / hydraulic</u>

8. Fahrwerk  
Running gear

801. Räder:  
Wheels: a) Durchmesser Vorn 14 " / 355,6 mm Hinten 14 " / 355,6 mm  
Diameter Front Rear

803. Bremsen:  
Brakes: a) Bremssystem Zweikreis hydraulisch / dual circuit hydraulic  
Braking system

b) Anzahl der Hauptzylinder 1 Tandem b1) Bohrung 20,64 / 20,64 mm  
Number of master cylinders Bore

c) Servo-Bremse ja / ~~nein~~ c1) Marke und Art VW vacuum  
Power assisted brakes yes/no Make and type

d) Bremskraftregler ja / ~~nein~~ d1) Lage Hinterachse / rear axle  
Braking adjuster yes/no Location

e) Anzahl der Zylinder je Rad  
Number of cylinders per wheel

1) Bohrung 48 mm 36 mm  
Bore

f) Trommelbremsen  
Drum brakes

1) Innendurchmesser \_\_\_\_\_ mm ( $\pm 1,5$  mm) \_\_\_\_\_ mm ( $\pm 1,5$  mm)  
Interior diameter

2) Anzahl der Bremsbacken je Rad  
Number of shoes per wheel

3) Bremsfläche \_\_\_\_\_ qcm \_\_\_\_\_ qcm  
Braking surface

4) Breite der Bremsbeläge \_\_\_\_\_ mm \_\_\_\_\_ mm  
Width of the shoes

g) Scheibenbremsen  
Disc brakes

1) Anzahl der Bremsbeläge je Rad 2 2  
Number of pads per wheel

2) Anzahl der Sättel je Rad 1 1  
Number of calipers per wheel

Vorn Front	Hinten Rear
<u>1</u>	<u>1</u>
<u>48</u> mm	<u>36</u> mm
<u>_____</u> mm ( $\pm 1,5$ mm)	<u>_____</u> mm ( $\pm 1,5$ mm)
<u>_____</u>	<u>_____</u>
<u>_____</u> qcm	<u>_____</u> qcm
<u>_____</u> mm	<u>_____</u> mm
<u>2</u>	<u>2</u>
<u>1</u>	<u>1</u>

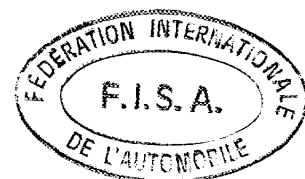



Marke Volkswagen  
Make

Modell Golf GTI 16 V  
Model

Homologation Nr. A-5295  
Homologation Nr.

	Vorn Front	Hinten Rear
3) Material der Bremssättel Caliper material	<u>Gußeisen / cast iron</u>	<u>Gußeisen / cast iron</u>
4) Maximale Dicke der Scheibe Maximum disc thickness	<u>20</u> mm	<u>10</u> mm
5) Außendurchmesser der Scheibe Exterior diameter of the disc	<u>239</u> mm (± 1 mm)	<u>226</u> mm (± 1 mm)
6) Außendurchmesser der Belagfläche Exterior diameter of the shoes rubbing surface	<u>238 ± 1</u> mm	<u>225 ± 1,5</u> mm
7) Innendurchmesser der Belagfläche Interior diameter of the shoes rubbing surface	<u>144 ± 1,5</u> mm	<u>138 ± 1,5</u> mm
8) Länge der Beläge über Alles Overall length of the shoes	<u>127 / 94 ± 1</u> mm	<u>76 ± 1,5</u> mm
9) Belüftete Scheiben ventilated disc	<u>ja / <del>nein</del></u> yes/no	<u><del>ja</del> / nein</u> yes/no
10) Bremsfläche je Rad Braking surface per wheel	<u>564</u> qcm	<u>496</u> qcm

h) Feststellbremse mechanisch / mechan  
Parking brake Command system

1) Betätigungssystem mechanisch / mechan  
Command system

2) Lage des Bremshebels Mitteltunnel / center tunnel  
Location of the lever

3) Wirkung auf die Räder XXXX Hinten  
On which wheels Front Rear

804. Lenkung: a) Art: Zahnstangenlenkung / rack and pinion steering  
Type

b) Übersetzungsverhältnis 20,8 : 1 c) Lenkhilfe ~~ja~~ / nein  
Ratio Power assisted yes/no

**9. Karosserie**  
Bodywork

901. Innen: a) Belüftung ja / ~~nein~~ b) Heizung ja / ~~nein~~  
Interior Ventilation yes/no Heating yes/no

f) Sonderausstattung Schiebedach ja / ~~nein~~ 1) Art gleitend / sliding  
Sun roof optional yes/no Type

2) Betätigungssystem Handkurbel / hand lever  
Command system

g) Öffnungssystem der Seitenscheiben: Handkurbel / hand lever  
Opening system for the side windows  
Vorn Handkurbel / hand lever  
Front  
Hinten ./.  
Rear

902. Außen: a) Anzahl der Türen 2 b) Heckklappe ja / ~~nein~~  
Exterior Number of doors Rear tailgate yes/no

c) Material der Türen Stahl / steel Vorn Stahl / steel  
Door material Front  
Hinten ./.  
Rear

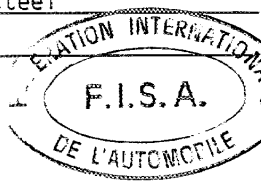

Marke Volkswagen Modell Golf GTI 16 V Homologation Nr. A-5295  
 Make \_\_\_\_\_ Model \_\_\_\_\_ Homologation Nr. \_\_\_\_\_  
 Make \_\_\_\_\_ Model \_\_\_\_\_ Homologation Nr. \_\_\_\_\_

- d) Material der Fronthaube Stahl / steel  
 Front bonnet material: \_\_\_\_\_
- e) Material der Heckhaube/Klappe Stahl / steel  
 Rear bonnet / tailgate material: \_\_\_\_\_
- f) Material der Karosserie Stahl / steel  
 Bodywork material: \_\_\_\_\_
- g) Material der Windschutzscheibe Verbundglas / laminated glass  
 Windscreen material: \_\_\_\_\_
- h) Material der Heckscheibe Sicherheitsglas / safety glass  
 Rear window material: \_\_\_\_\_
- i) Material der hinteren Seitenscheiben Sicherheitsglas / safety glass  
 Rear quarter lights material: \_\_\_\_\_
- k) Material der Seitenscheiben Sicherheitsglas / safety glass  
 Side window material: Vorn / front \_\_\_\_\_  
Hinten / rear Sicherheitsglas / safety glass \_\_\_\_\_
- l) Material der vorderen Stoßstange Stahl + PVC / steel + PVC  
 Material of the front bumper: \_\_\_\_\_
- m) Material der hinteren Stoßstange Stahl + PVC / steel + PVC  
 Material of the rear bumper: \_\_\_\_\_

**Zusätzliche Informationen**  
 Complementary informations

327 m. Winkel-Differenz Einlaß- zu Auslaßventil = 25°  
 angl. difference between inlet- to exhaust valves = 25°

Achsantrieb: Finaldrive:	Übersetzungsverhältnis / Ratio:	Anzahl der Zähne / number t
	5,077	= 66 : 13
	4,643	= 65 : 14
	4,200	= 63 : 15
	3,938	= 63 : 16
	3,389	= 61 : 18

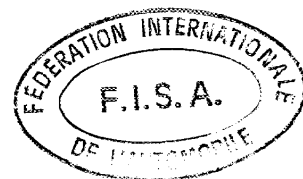

Marke Volkswagen  
Make

Modell Golf GTI 16 V  
Model

Homologation Nr. A-5295  
Homologation Nr.

**Fotos**  
Photos

**Motor**  
Engine

C) Rechte Seitenansicht Motor (ausgebaut)  
Right hand view of dismantled engine

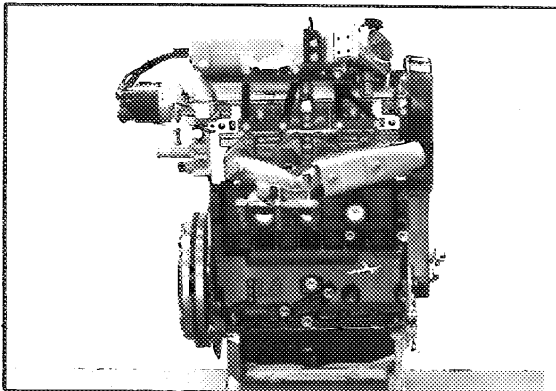

D) Linke Seitenansicht Motor (ausgebaut)  
Left hand view of dismantled engine

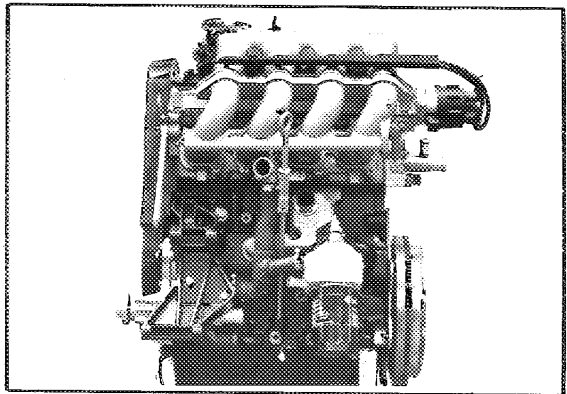

E) Motor im Motorraum  
Engine in its compartment

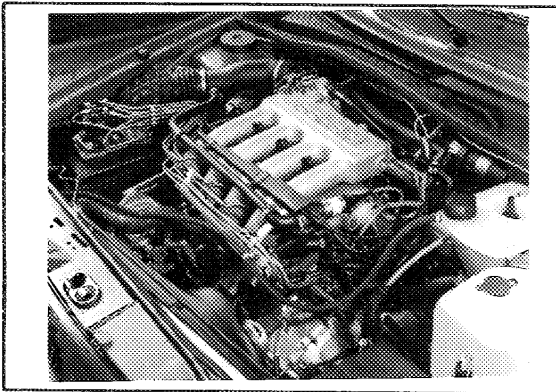

F) Zylinderkopf allein  
Bare cylinderhead

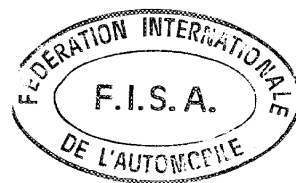
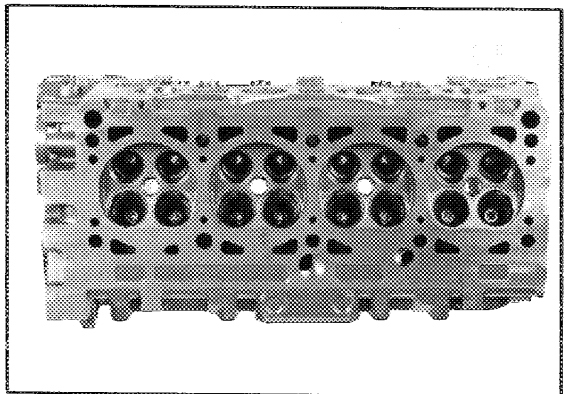

Marke Volkswagen  
Make

Modell Golf GTI 16 V  
Model

Homologation Nr. A-5295  
Homologation Nr.

G) **Verbrennungsraum**  
Combustion chamber

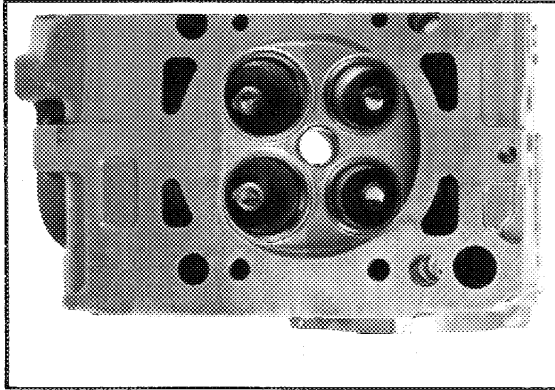

H) **Vergaser oder Einspritzsystem**  
Carburetor(s) or injection system

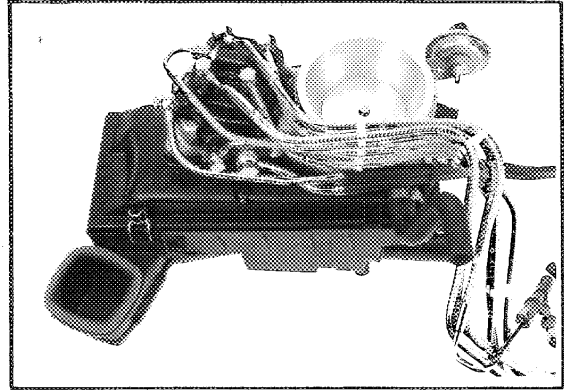

I) **Einlaßkrümmer**  
Inlet manifold

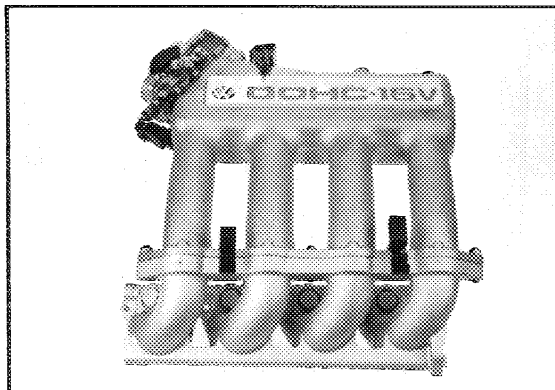

J) **Auspuffkrümmer**  
Exhaust manifold

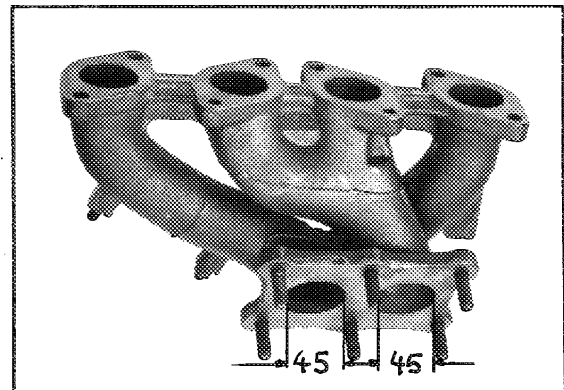

**Getriebe**  
Transmission

S) **Getriebegehäuse und Kupplungsglocke**  
Gearbox casing and clutch bellhousing

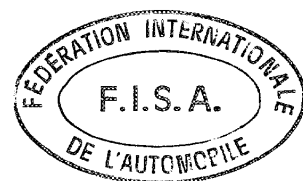
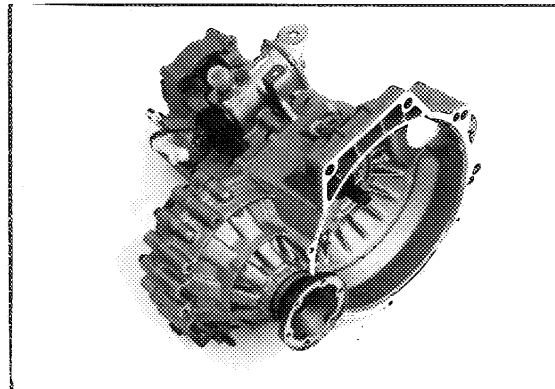

Marke Volkswagen

Modell Golf GTI 16 V

Homologation Nr. A-5295

### Radaufhängung

Suspension

T) Vorderachse vollständig ausgebaut  
Complete dismantled front running gear

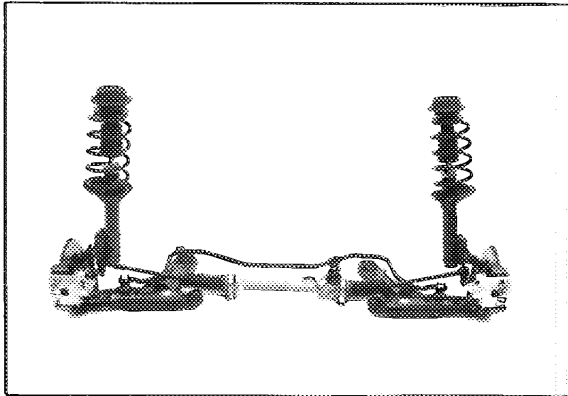

U) Hinterachse vollständig ausgebaut  
Complete dismantled rear running gear

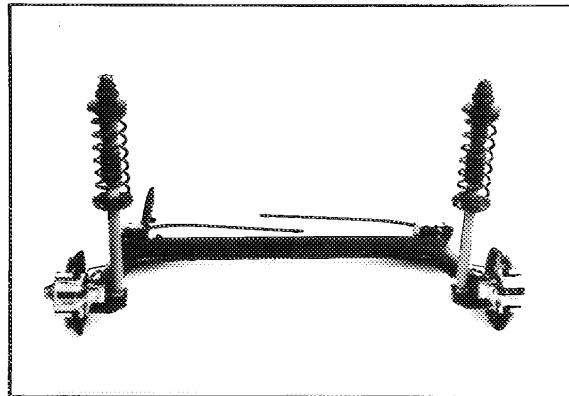

### Fahrwerk

Running gear

V) Bremsen vorn  
Front brakes

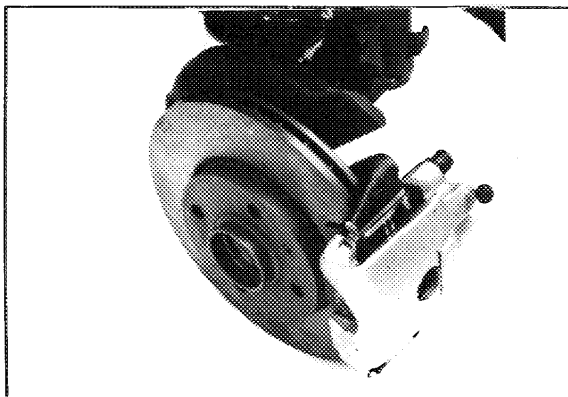

W) Bremsen hinten  
Rear brakes

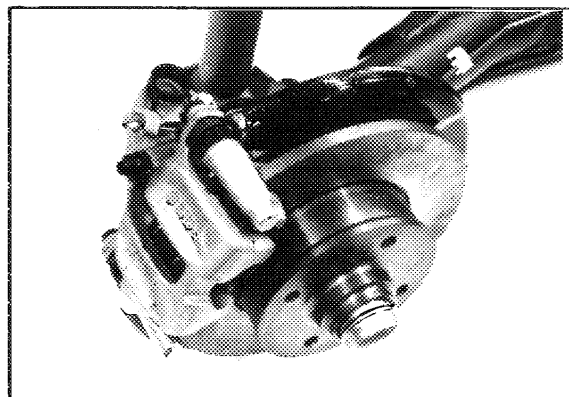

### Karosserie

Body

X) Armaturenbrett  
Dashboard

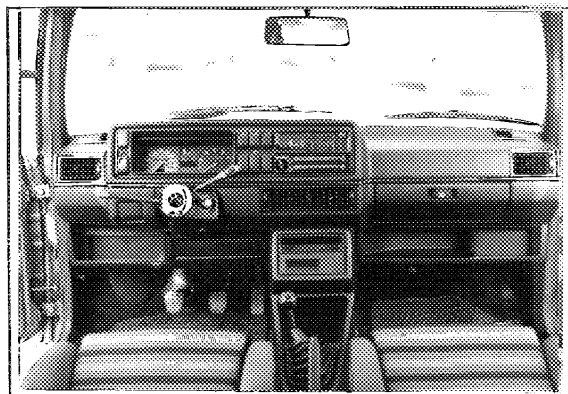

Y) Schiebedach  
Sunroof

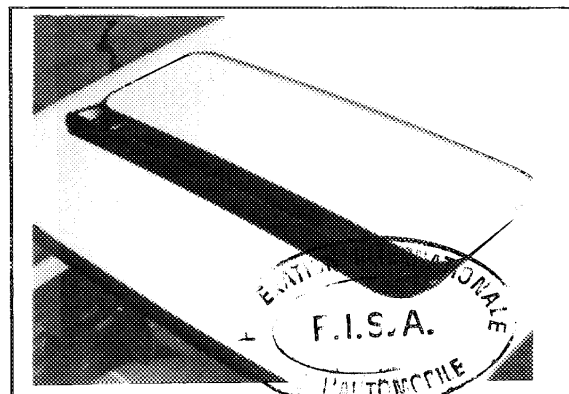

Marke Volkswagen  
Make

Modell Golf GTI 16 V  
Model

Homologation Nr. A-5291  
Homologation Nr.

**Zeichnungen**  
Drawings

**Motor**  
Engine

- I. Einlaßöffnungen im Ansaugkrümmer (Abmessungstoleranzen:  $-2\%$ ,  $+4\%$ )  
Cylinderhead inlet ports manifold side — tolerances on dimensions  $-2\%$ ,  $+4\%$

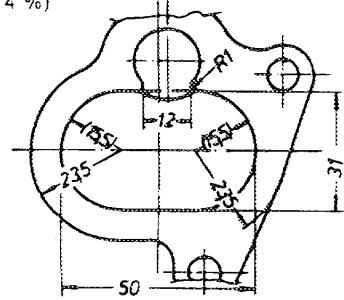

- II. Einlaßöffnungen im Zylinderkopf (Abmessungstoleranzen:  $-2\%$ ,  $+4\%$ )  
Inlet manifold ports cylinderhead side — tolerances on dimensions  $-2\%$ ,  $+4\%$

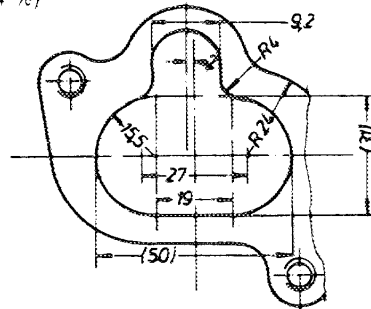

- III. Auslaßöffnungen im Auspuffkrümmer (Abmessungstoleranzen:  $-2\%$ ,  $+4\%$ )  
Cylinderhead exhaust ports manifold side — tolerances on dimensions  $-2\%$ ,  $+4\%$

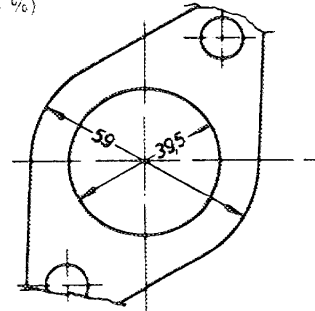

- IV. Auslaßöffnungen im Zylinderkopf (Abmessungstoleranzen:  $-2\%$ ,  $+4\%$ )  
Exhaust manifold ports cylinderhead side — tolerances on dimensions  $-2\%$ ,  $+4\%$

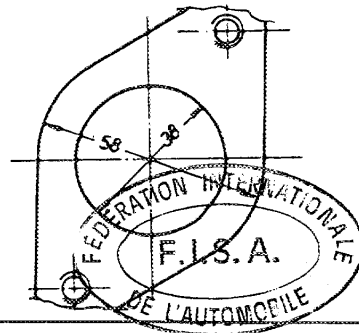

Marke Volkswagen  
Make

Modell Golf GTI 16 V  
Model

Homologation Nr. A - 5295  
Homologation Nr.

**Radaufhängung**  
Suspension

XV. System der Radaufhängung gem. Art. 705 oder anstelle der Fotos T und U  
Suspension system according to article 705 or replacing photos T and U

~~Anforderung:~~  
~~anforderung:~~

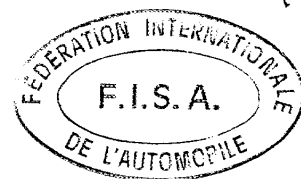
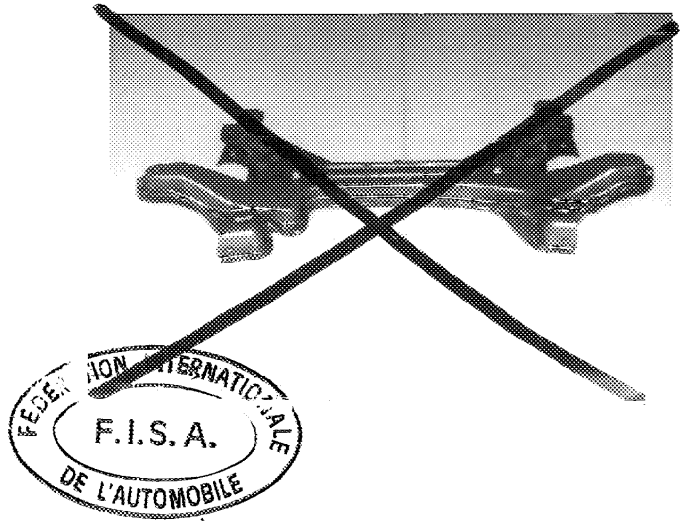

Gruppe A/B  
 Group

Marke Volkswagen Modell Golf GTI 16 V  
 Make Volkswagen Model Golf GTI 16 V

Innenabmessungen gem. Homologationsbestimmungen  
 Interior dimensions as defined by the Homologation Regulations

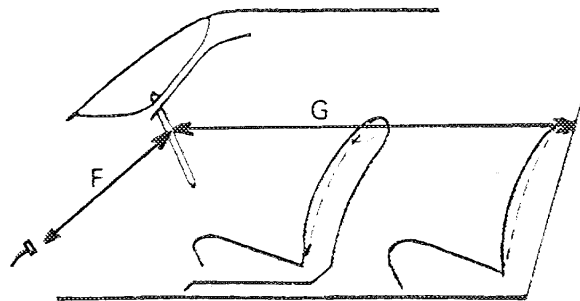
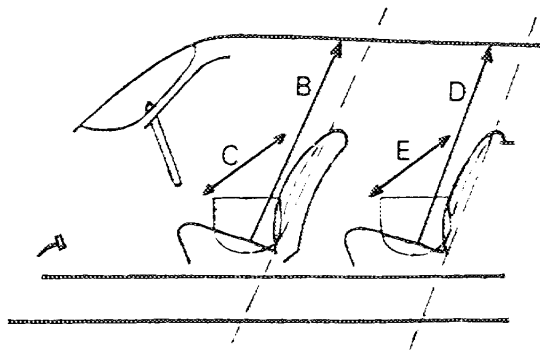

B Höhe über den Vordersitzen 967 mm  
 Height above front seats

C Breite über den Vordersitzen 1312 mm  
 Width at front seats

D Höhe über den Rücksitzen 952 mm  
 Height above rear seats

E Breite über den Rücksitzen 1308 mm  
 Width at rear seats

F Abstand Lenkrad — Bremspedal 557 mm  
 Steering wheel — brake pedal

G Abstand Lenkrad — Hintere Trennwand 1596 mm  
 Steering wheel — rear bulkhead

H = F + G = 2153 mm

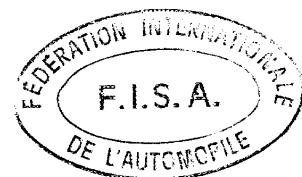



**FÉDÉRATION INTERNATIONALE DU SPORT AUTOMOBILE**  
**ONS Oberste Nationale Sportkommission für den Automobilsport in Deutschland GmbH**

Homologation Nr.

**A - 5295**

Nachtrag Nr.  
Extension Nr.

**01 / 01 VO**

Nachtrag zum offiziellen Testblatt der FISA  
 Form of extension to the official FISA-Homologation

**VO** **Ausstattungsvariante**  
 Option variant

Homologation gültig ab 1. MARS 1986 in Gruppe A  
 Homologation valid as from in group

Fahrzeughersteller Volkswagen AG Modell und Typ Golf GTI 16 V - 19  
 Manufacturer of the car Model and type

**Überrollbügel/-käfig**  
 Rollbar/rollcage

	Hauptbügel Main rollbar	Diagonalstrebe Longitudinal/diagonal strut	Vorderbügel Front rollbar
Bügelhersteller Rollbar manufacturer	Winfried Matter GmbH, Industriegebiet, 7523 Graben-Neudorf West-Germany, Telefon: 07255-5071 Telex: 7822215 mat d		
Material Material	ALZn Mg 1	ALZn Mg 1	ALZn Mg 1
Außendurchmesser Exterior diameter	40 mm	40 mm / mm	40 mm
Wandstärke Wall thickness	3,5 mm	3,5 mm / mm	3,5 mm
Streckgrenze Elastic limit	290-345 kg/mm <sup>2</sup>	290-345 kg/mm <sup>2</sup> / kg/mm <sup>2</sup>	290-345 kg/mm <sup>2</sup>
Zugfestigkeit Tensile strength	350-390 kg/mm <sup>2</sup>	350-390 kg/mm <sup>2</sup> / kg/mm <sup>2</sup>	350-390 kg/mm <sup>2</sup>
Gesamtgewicht inkl. Befestigungsvorrichtungen Total weight including fixings	25,0 kg		

Kompletter Überrollbügel/-käfig ausgebaut  
 Complete rollbar/rollcage outside the car

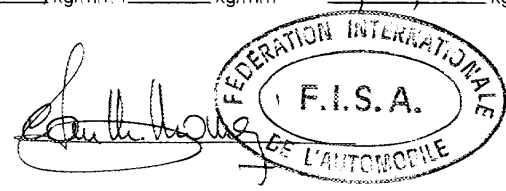
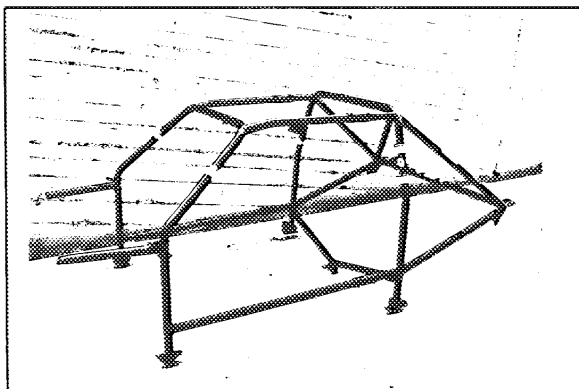

Hiermit wird bestätigt, daß der beschriebene Überrollbügel/-käfig den Anforderungen des Anhangs J der FISA entspricht insbesondere in Bezug auf seine Befestigungen, Verbindungen und Beanspruchungswerte.  
 We certify that the present rollbar/rollcage complies with the conditions of the FIA Appendix J, in particular with regard to its attachments, its connections and its stress resistance.

Unterschrift des Fahrzeugherstellers  
 Signature of the car manufacturer representative

*Frank-Berthel Schmitt*

Marke Volkswagen  
Make

Modell Golf GTI 16 V  
Model

Homologation Nr. A-5295  
Homologation Nr.

01/01V0

Fotos oder Zeichnungen der Befestigungen an der Karosserie:  
Photos or drawings of the attachments on the Body

Nachtrag Nr. \_\_\_\_\_  
Ext. Nr.

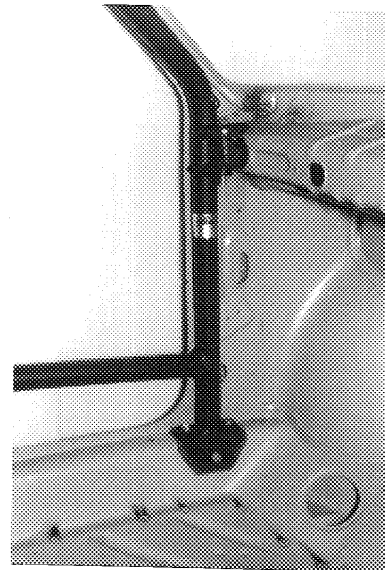
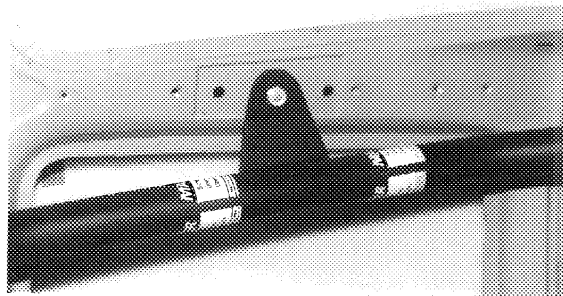
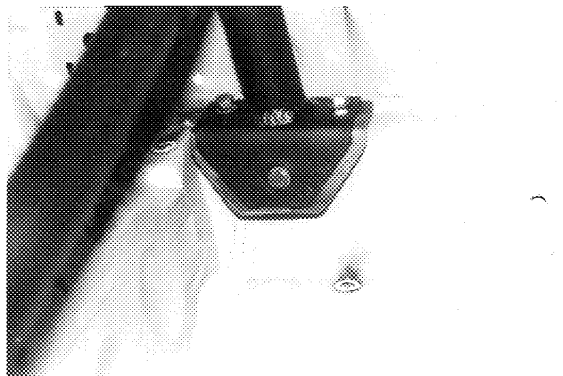
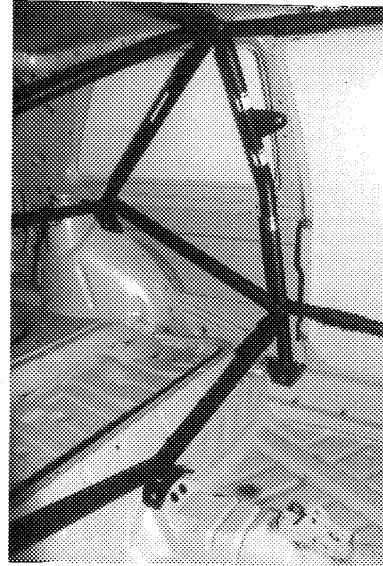
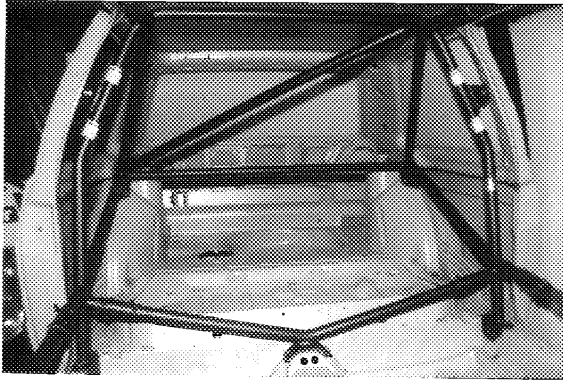

Marke Volkswagen  
Make

Modell Golf GTI 16 V  
Model

Homologation Nr. A-5295  
Homologation Nr.

Nachtrag Nr. 01/01V0  
Ext. Nr.

Fotos oder Zeichnungen der Befestigungen an der Karosserie:  
Photos or drawings of the attachments on the Body

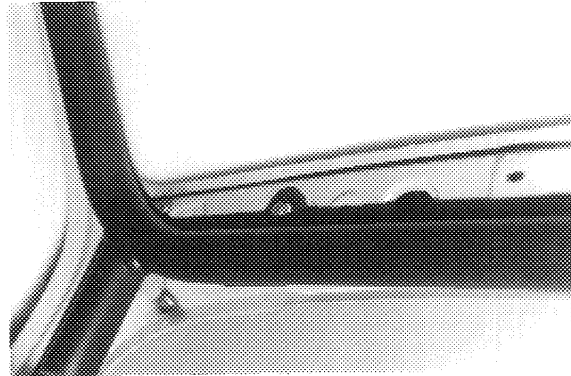
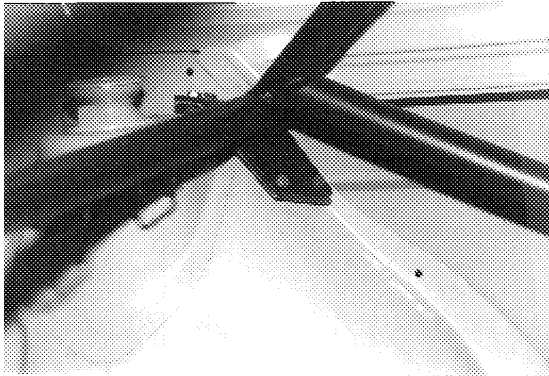

# FÉDÉRATION INTERNATIONALE DU SPORT AUTOMOBILE

ONS Oberste Nationale Sportkommission für den Automobilsport in Deutschland GmbH

Homologation Nr.

**A - 5295**

Nachtrag Nr.  
Extension N°:

**02 / 02 VO**

## Nachtrag zum offiziellen Testblatt der FISA

Form of extension to the official FISA-Homologation

- ET** Normale Weiterentwicklung des Typs: ab Fahrgestell-Nr.: \_\_\_\_\_  
Normal evolution of the type: as from chassis number.
- ES** Sportevolution  
Sporting evolution.
- VF** Liefervariante  
Supply variant.
- VO** Ausstattungsvariante  
Option variant.
- ER** Berichtigung  
Erratum.

Homologation gültig ab: - 1 MARS 1986 in Gruppe: A  
Homologation valid as from: in group

Hersteller: Volkswagen AG Modell und Typ: Golf GTI 16 V  
Manufacturer: Model and type

Seite od. Nachtrag Page or ext.	Artikel Art.	Beschreibung Description	Phot
7	401 a	Kraftstofftank / fuel tank	1
7	401 b	im Kofferraum / in the luggage-compartment	2
7	401c/d	Aluminium / max. 100 l	
7	606	Verstärkte Antriebsgelenkwellen / reinforced drive shafts	4
8	706	Stabilisator vorne / anti-roll bar front	5
8	706	Stabilisator hinten, einstellbar / anti-roll bar rear, adjustable	6
7	701	Querlenker vorne verstärkt / wishbone front reinforced	7
7	701	Querlenker vorne mit Unibalgelenk / wishbone front with unibal joint	8
7	701	Federbeinlagerung verstärkt excentrisch / suspension strut mounting reinforced eccentric	9 +
7	701 a	Radlagergehäuse vorne, verstärkt / wheel bearing housing front reinforced	11
7	701 a	Radlagergehäuse verstärkt mit angeschraubtem Lenkstock- hebel / wheel bearing housing reinforced with bolted-on steering lever	12

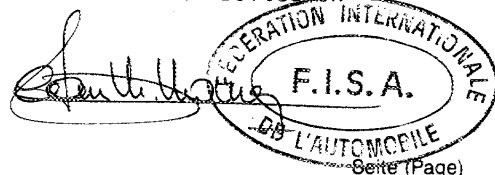

Marke Volkswagen Modell Golf GTI 16 V Homologations Nr. A-5295  
 Make Volkswagen Model Golf GTI 16 V Homologation Nr. A-5295

Nachtrag Nr. 02/02V0  
 Ext. Nr. 02/02V0

Seite od. Nachtrag Page or ext.	Artikel Art.	Beschreibung Description	
			Phot
7	701	Federbein vorn und hinten verstärkt, mit unterschiedlichen Stoßdämpferlängen / reinforced strut front and rear, with different lenght shock absorber	13 +1
7	701	Federbeinbefestigung mit Höhenausgleich / strut mounting with height adjustment	15 +1
7	701	Zentralverschluß / centre wheel lock	17
7	701	Radnabe mit Stehbolzen, vorn und hinten / wheel hub with studs, front and rear	18
8	803 h	Hydraulische Handbremse / hydraulic hand brake	19
8	803 h	Hydraulische Handbremse in Kombination mit mechanischer Betätigung / hydraulic hand brake combined with mechanically operated brakes	20
8	803 b	Bremssystem mit 2 Hauptbremszylindern wahlweise ohne Servo mit Waagebalken verstellbar: Zylinder Ø 15,8-17, 8-19, 0-22,2 mm / brake-system with two brake master cylinders an adjustable compensating bar, optional without servo; cylinder Ø 15,8-17, 8-19, 0-22,2 mm	21
8	803 h	Absperrventil anstelle Handbremse / cut-off valve instead of hand brake	22
8	803 d	Bremskraftverteilungsventil im Fahrgastraum / brake force regulation valve in passenger compartment	23
7	701	Querlenker vorne verstärkt mit Unibalgelenk wishbone front reinforced with unibal joint	24
8	803 d	Entfall: Bremskraftregler / without brake pressure regulator	
8	803 c	Entfall: Brems-Servo-Anlage / without brake servo	
8	803 b1	Hauptbremszylinder wahlweise mit Durchmesser 23,81 / 23,81 23,81 / 19,05 master cylinder optional with diameter 23,81 / 23,81 23,81 / 19,05	
8	804 b	Lenkung : Übersetzungsverhältnis 16,8 : 1 steering: ratio 16,8 : 1	
8	804 c	Servo Lenkung / steering: power assisted	

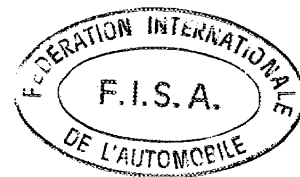

Marke Volkswagen  
Make

Modell Golf GTI 16 V  
Model

Homologations Nr. A-5295  
Homologation Nr.

Fotos  
Photos

Nachtrag Nr. 02 / 02 V0  
Ext. Nr.

1

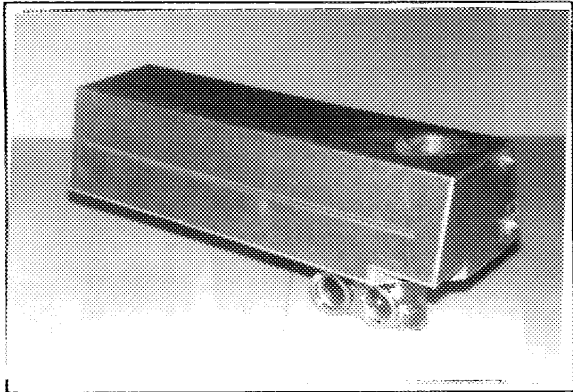

2

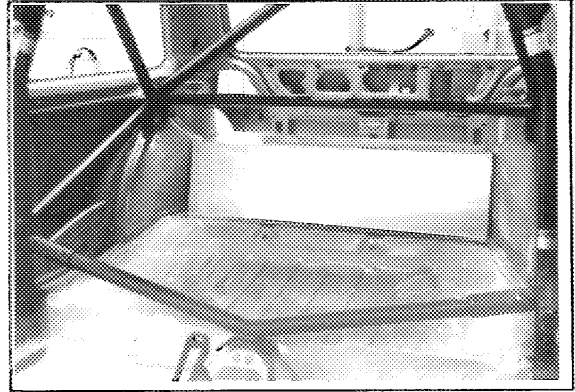

3

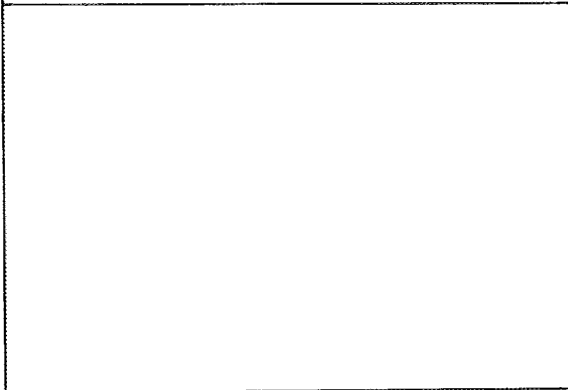

4

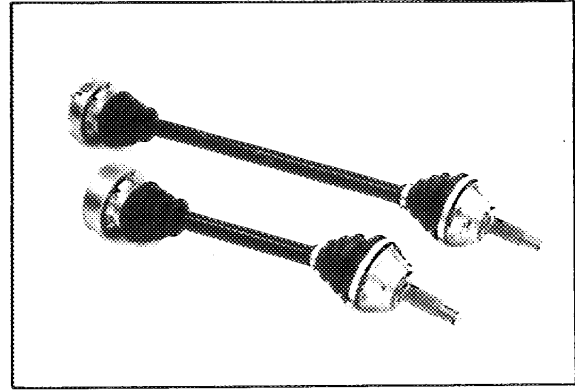

5

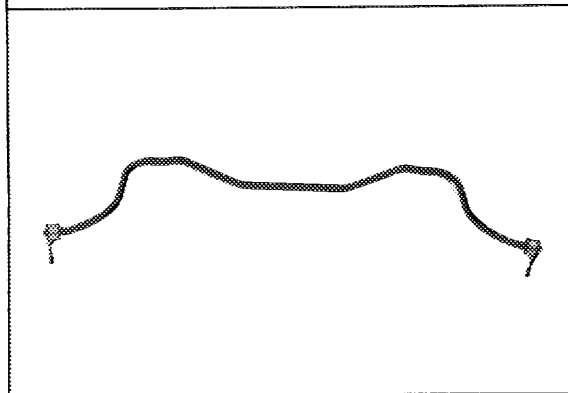

6

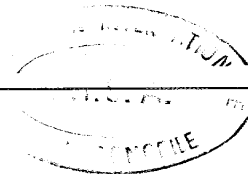
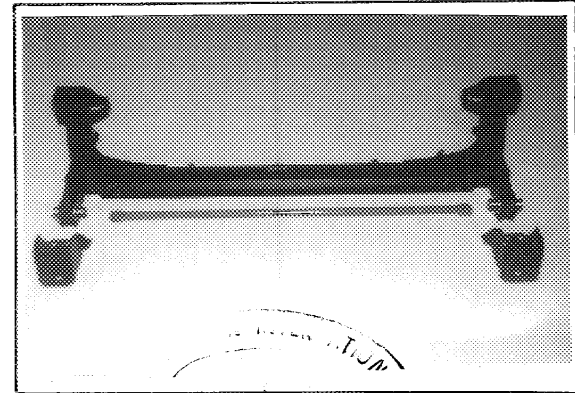

Marke Volkswagen  
Make

Modell Golf GTI 16 V  
Model

Homologations Nr. A-5295  
Homologation N°

Fotos  
Photos

Nachtrag Nr. 02/02V  
Ext. Nr.

7

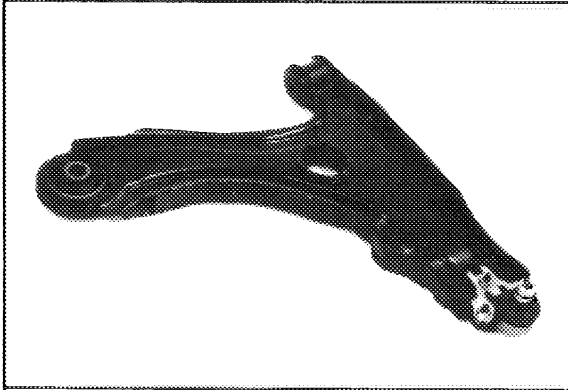

8

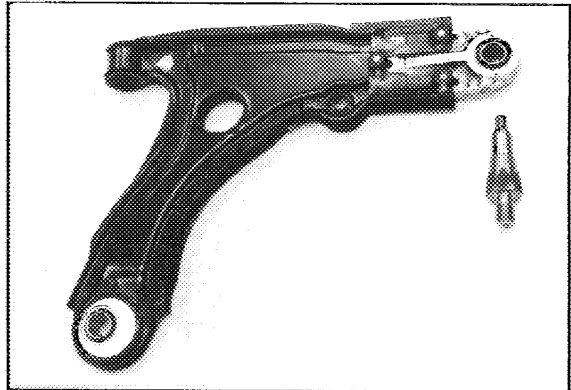

9

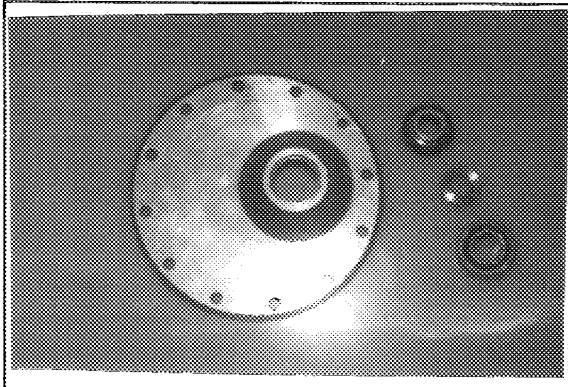

10

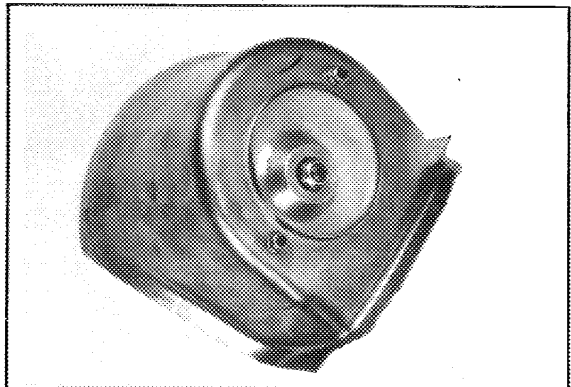

11

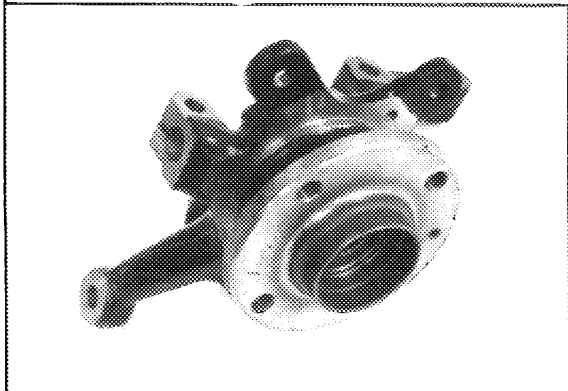

12

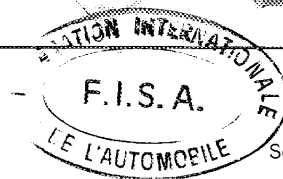
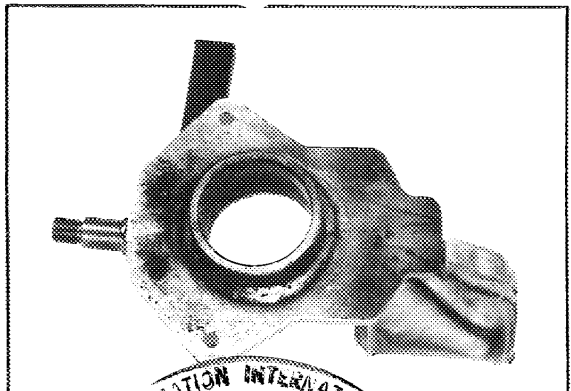

Marke Volkswagen

Modell Golf GTI 16 V

Homologations Nr A-5293

02/02/00

Fotos

Nachtrag Nr \_\_\_\_\_  
Ext. Nr \_\_\_\_\_

13

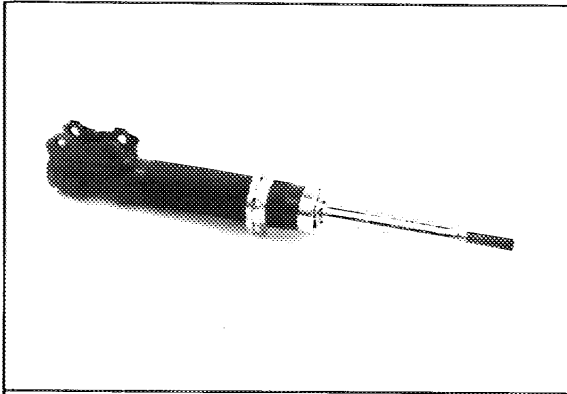

14

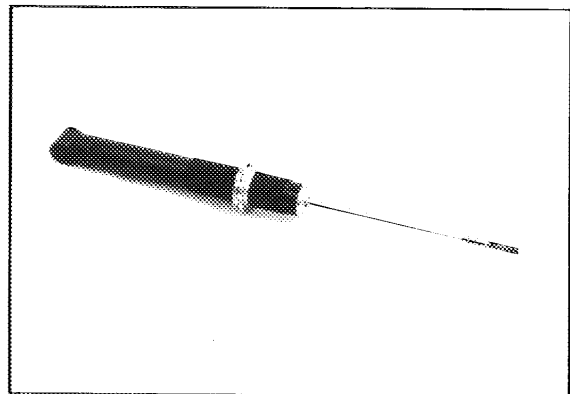

15

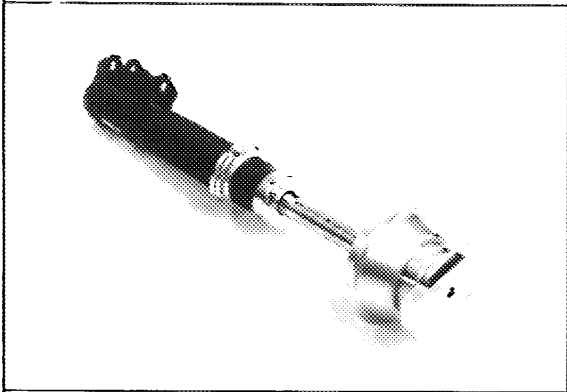

16

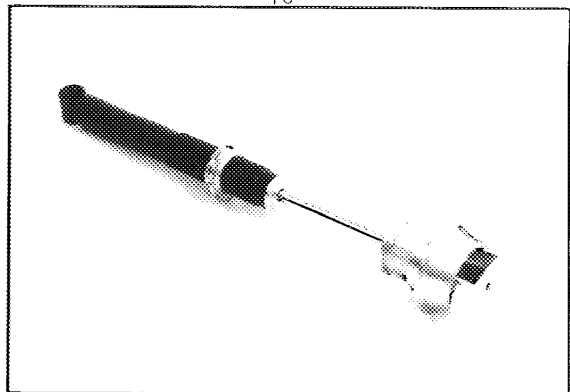

17

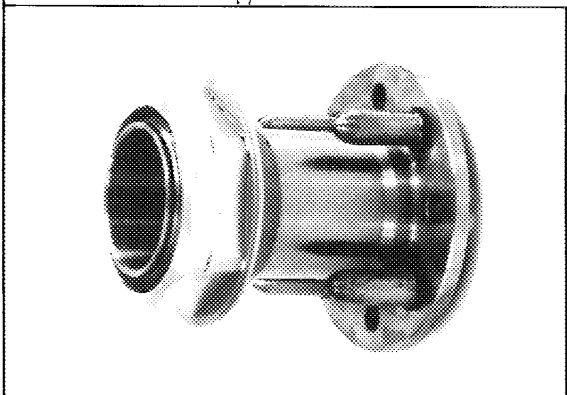

18

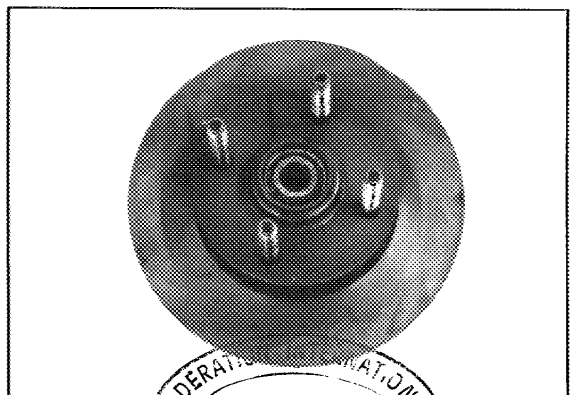



Marke Volkswagen  
Make

Modell Golf GTI 16 V  
Model

Homologations Nr. A-5299  
Homologation Nr.

Fotos  
Photos

Nachtrag Nr. 02/92K  
Ext. Nr.

19

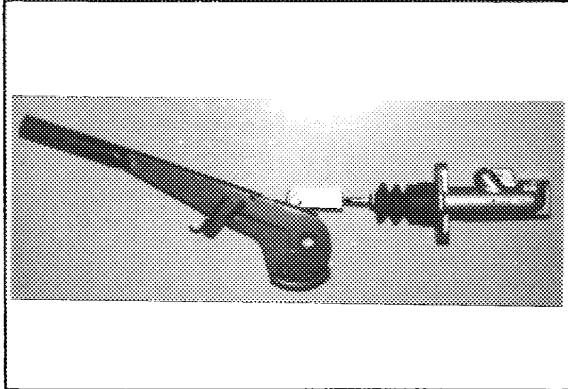

20

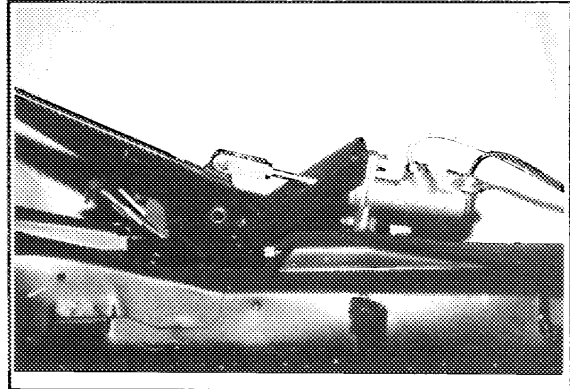

21

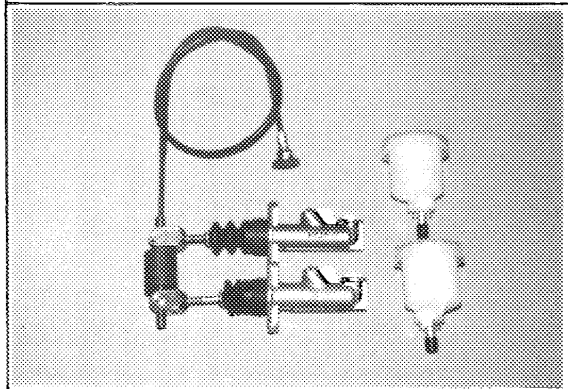

22

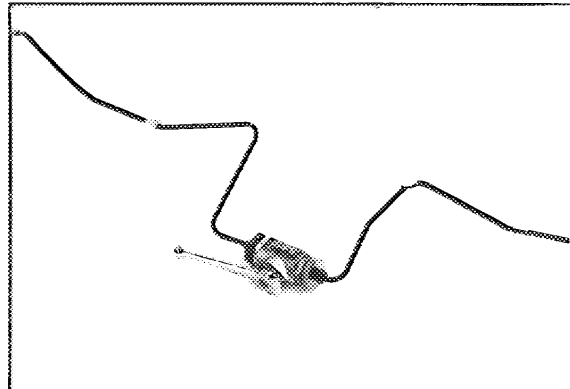

23

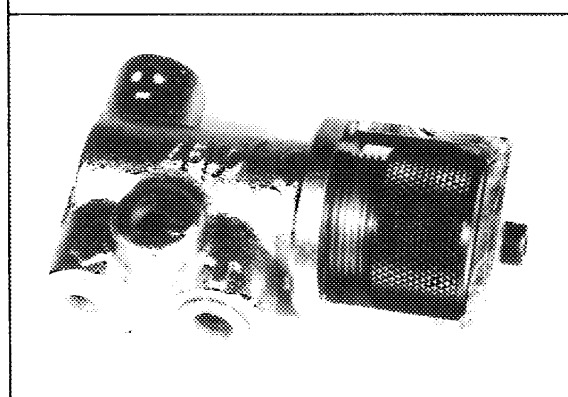

24

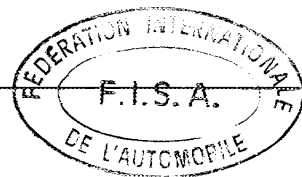
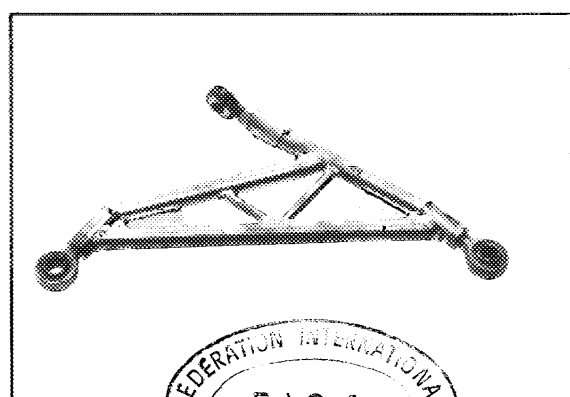

Marke Volkswagen  
 Make

Modell Golf GTI 16 V  
 Model:

Homologations Nr. A-5207  
 Homologation Nr.

Nachtrag Nr. 02 / 02 V0  
 Ext. Nr.

Seite od. Nachtrag Page or ext.	Artikel Art.	Beschreibung Description
		Version Girling + VW Photos 25-29 u. 34-37

8	803. Bremsen: Brakes:	Vorn Front					Hinten Rear				
		e) Anzahl der Zylinder je Rad Number of cylinders per wheel		1 oder/or 4					1, 2 oder/or 4		
1) Bohrung Bore		38,1, 42,8, 48 oder/or 54					33,9, 35, 38 oder/or 42,8				
g) Scheibenbremsen Disc brakes		2					2				
1) Anzahl der Bremsbeläge je Rad Number of pads per wheel		1					1				
2) Anzahl der Sättel je Rad Number of calipers per wheel											
3) Material der Bremssättel Caliper material		Aluminium - Guß-cast					Aluminium - Guß-cast				
4) Maximale Dicke der Scheibe Maximum disc thickness		20, 22, 25 oder/or 28					10 oder/or 22				
5) Außendurchmesser der Scheibe Exterior diameter of the disc		304	260	266	280	256	240	260	266	225,5	240
6) Außendurchmesser der Belagfläche Exterior diameter of the shoes rubbing surface		303	259	265	279	254	239	259	265	224	239
7) Innendurchmesser der Belagfläche Interior diameter of the shoes rubbing surface		200	158	164	178	160	153	174	180	142	151
8) Länge der Beläge über Alles Overall length of the shoes		96	94	94	94	110	62	62	62	77	59
9) Belüftete Scheiben Ventilated disc		wahlweise / optional					wahlweise / optional				
10) Bremsfläche je Rad Braking surface per wheel		813,4	661	680	724	611	529	578	593	471	539

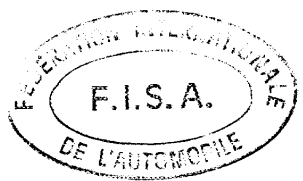

Marke Volkswagen  
 Make

Modell Golf GTI 16 V  
 Model:

Homologations Nr. A-5295  
 Homologation Nr.

Nachtrag Nr. 02/02 VO  
 Ext. Nr.

Seite od. Nachtrag Page or ext.	Artikel Art.	Beschreibung Description
		Version Lockheed Photos 30-37

- 8 803. Bremsen:  
 Brakes:
- e) Anzahl der Zylinder je Rad  
 Number of cylinders per wheel
- 1) Bohrung  
 Bore
- g) Scheibenbremsen  
 Disc brakes
- 1) Anzahl der Bremsbeläge je Rad  
 Number of pads per wheel
- 2) Anzahl der Sättel je Rad  
 Number of calipers per wheel
- 3) Material der Bremssättel  
 Caliper material
- 4) Maximale Dicke der Scheibe  
 Maximum disc thickness
- 5) Außendurchmesser der Scheibe  
 Exterior diameter of the disc
- 6) Außendurchmesser der Belagfläche  
 Exterior diameter of the shoes rubbing surface
- 7) Innendurchmesser der Belagfläche  
 Interior diameter of the shoes rubbing surface
- 8) Länge der Beläge über Alles  
 Overall length of the shoes
- 9) Belüftete Scheiben  
 Ventilated disc
- 10) Bremsfläche je Rad  
 Braking surface per wheel

Vorn Front					Hinten Rear			
4					2			
38,1, 41,3					42,8, 44,5 oder/or 41,3			
2					2			
1					1			
Aluminium - alloy					Aluminium - alloy			
20, 22, 25 oder/or 28					10, 20 oder/or 22			
239	260	266	280	304	239	260	266	280
238	259	265	279	303	238	259	265	279
137	158	164	178	200	152	172	178	192
112					69			
wahlweise / optional					wahlweise / optional			
594	661	680	724	813	526	588	605	643

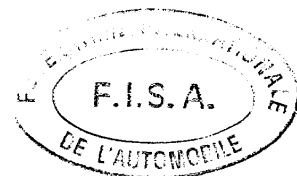

Marke Volkswagen  
Make

Modell Golf GTI 16 V  
Model

Homologations Nr. A - 5295  
Homologation Nr.

Fotos  
Photos

Nachtrag Nr. 02 / 02 VI  
Ext. Nr.

Version Girling

25

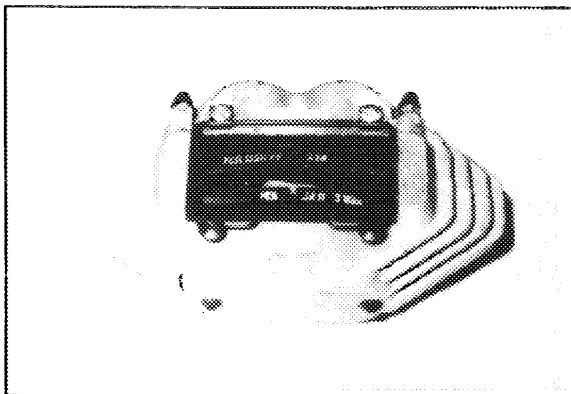

26

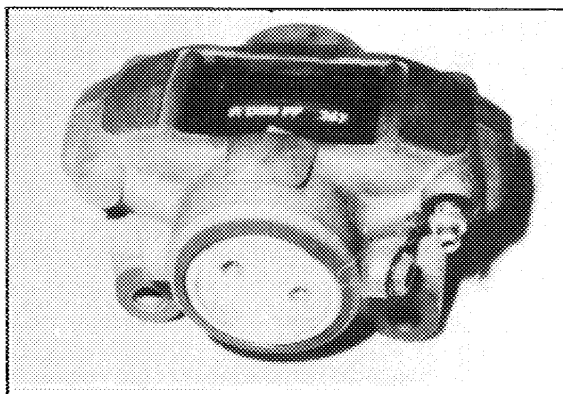

27

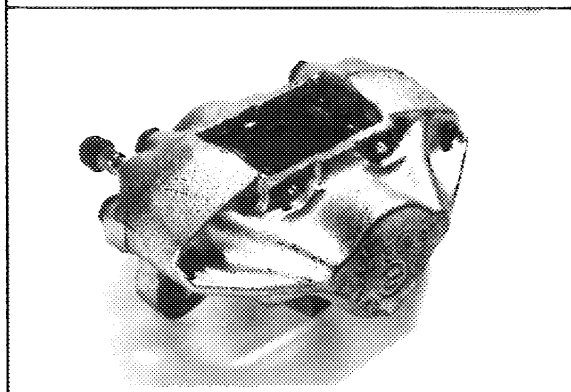

28

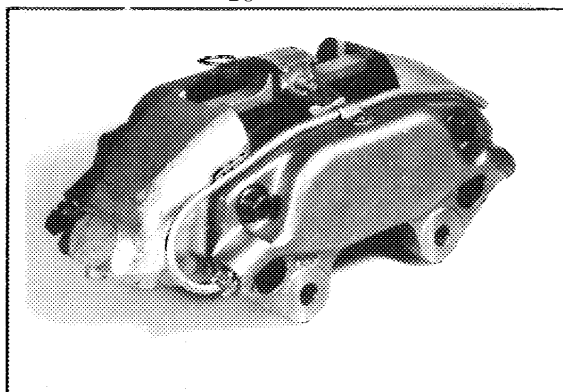

29

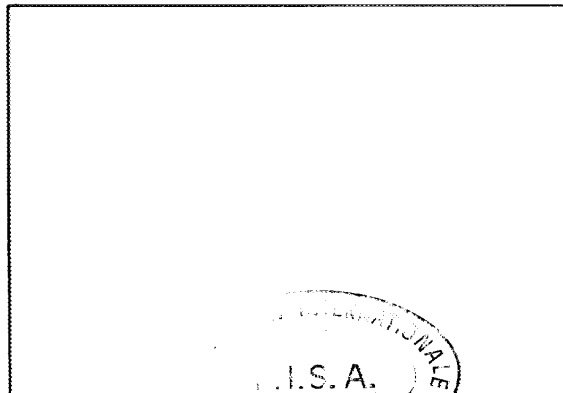
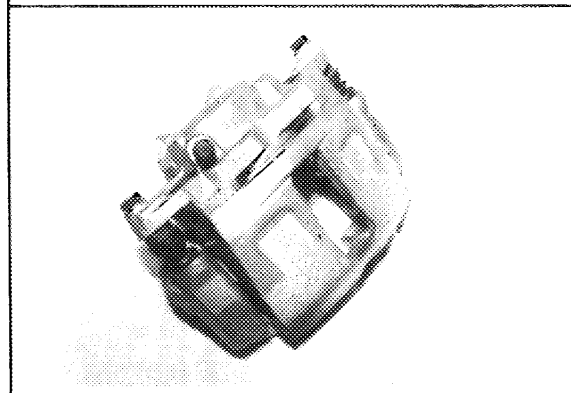

Marke Volkswagen  
Make

Modell Golf GTI 16 V  
Model

Homologations Nr. A-5295  
Homologation Nr.

Fotos  
Photos

Nachtrag Nr. 02/02V  
Ext. Nr.

30

Version Lookhead

31

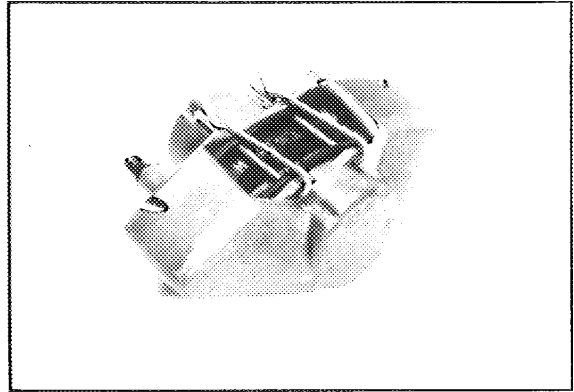
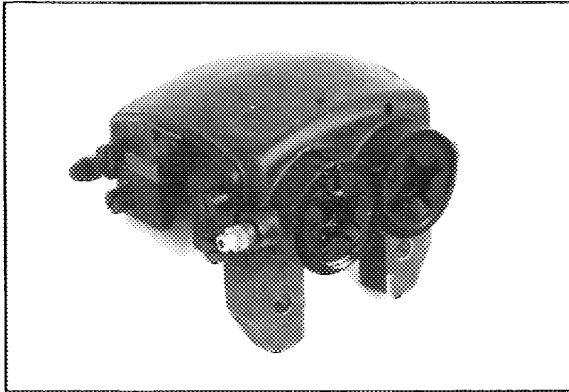

32

33

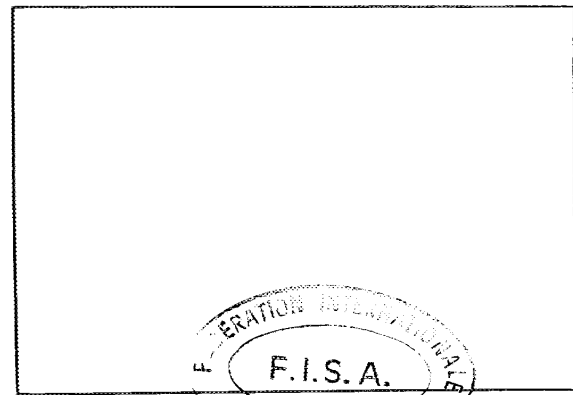
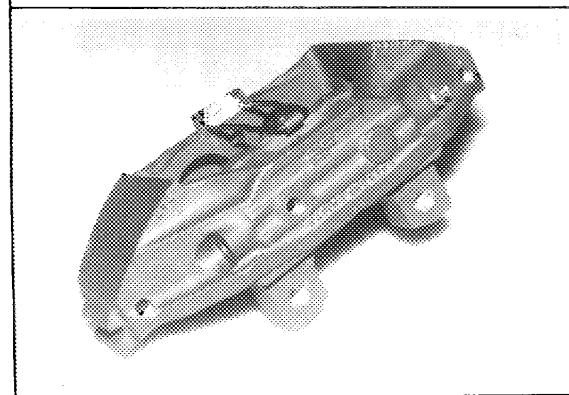
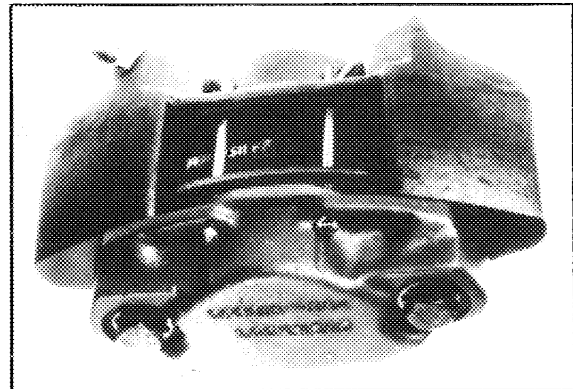
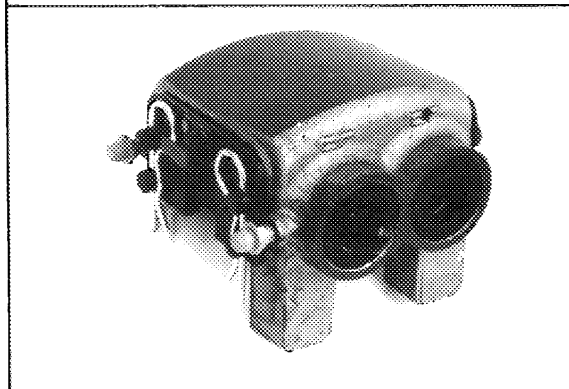

Marke Volkswagen  
Make

Modell Golf GTI 16 V  
Model

Homologations Nr. 1-528  
Homologation Nr.

Fotos  
Photos

Nachtrag Nr. 02 / 02 V  
Ext. Nr.

34

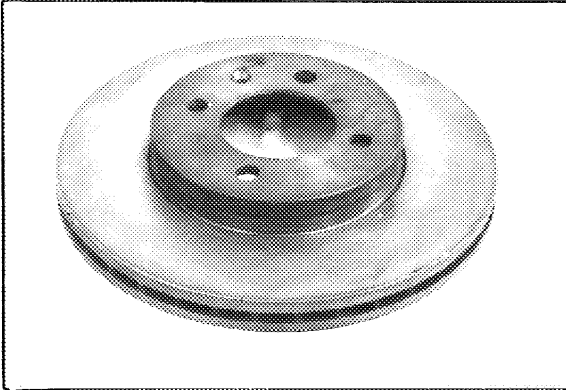

35

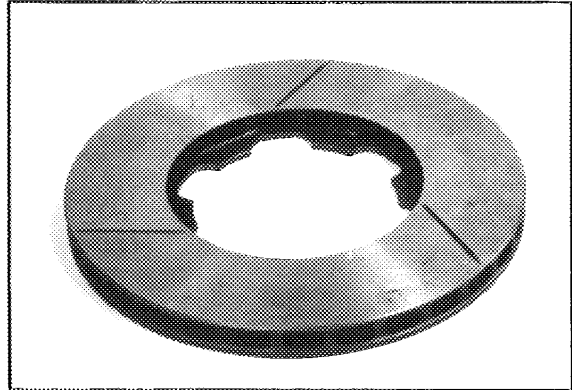

36

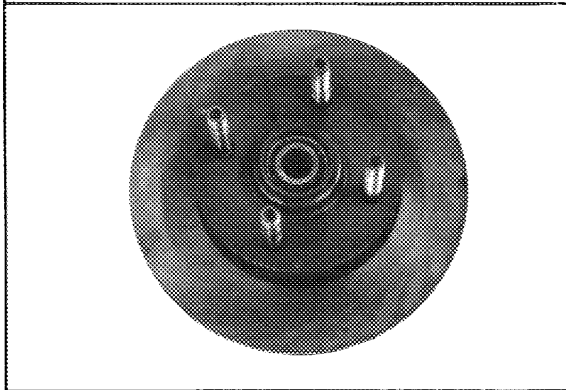

37

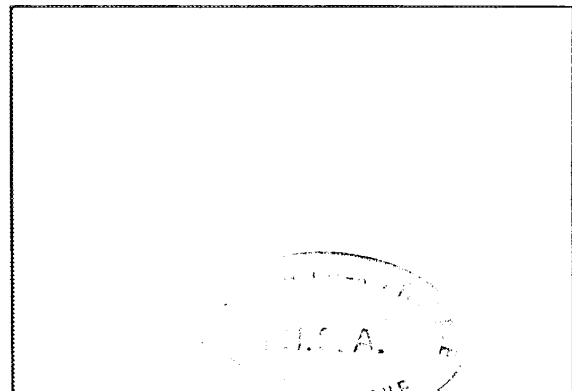
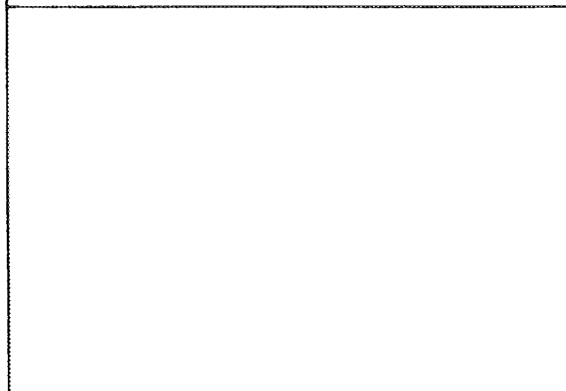
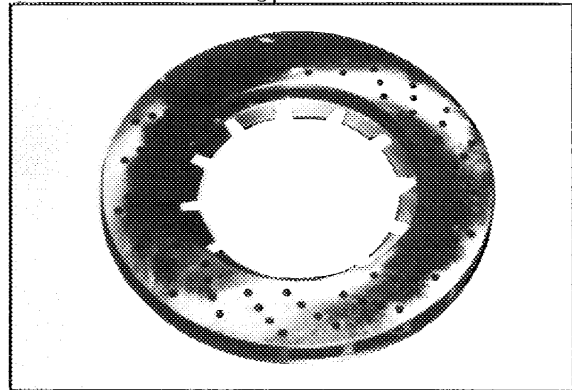



# FEDERATION INTERNATIONALE DU SPORT AUTOMOBILE

Homologation N°

**A - 5295**

Extension N°

**03 - 01 ER**

FICHE D'EXTENSION A L'HOMOLOGATION OFFICIELLE FISA  
FORM OF EXTENSION TO THE OFFICIAL FISA HOMOLOGATION

- ES** Evolution sportive du type / Sporting evolution of the type
- ET** Evolution normale du type / Normal evolution of the type
- VF** Variante de fourniture / Supply variant
- VO** Variante option / Option variant
- ER** Errata / Erratum

Homologation valable dès le \_\_\_\_\_ en groupe \_\_\_\_\_  
Homologation valid as from 1 AVR. 1986 in group A

Constructeur \_\_\_\_\_ Modèle et type \_\_\_\_\_  
Manufacturer VOLKSWAGEN Model and type Golg GTi 16V

Page ou ext. Page or ext.	Art. Art.	Description Description
15		THIS ERRATUM CANCELS PHOTO GIVEN ON PAGE 15.

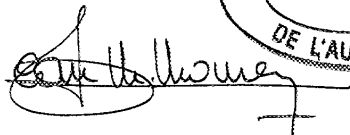
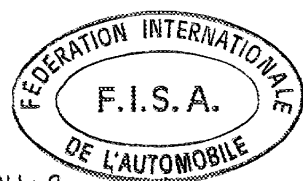
**FÉDÉRATION INTERNATIONALE DU SPORT AUTOMOBILE**  
**ONS Oberste Nationale Sportkommission für den Automobilsport in Deutschland GmbH**

Homologation Nr.

A 5295

Nachtrag Nr.  
Extension N:

04 - 03 VO

Nachtrag zum offiziellen Testblatt der FISA  
 Form of extension to the official FISA-Homologation

- ET** Normale Weiterentwicklung des Typs: ab Fahrgestell -Nr.: \_\_\_\_\_  
Normal evolution of the type as from chassis number
- ES** Sportevolution  
Sporting evolution
- VF** Liefervariante  
Supply variant
- VO** Ausstattungsvariante  
Option variant
- ER** Berichtigung  
Erratum

Homologation gültig ab: 1 JAN. 1987 in Gruppe: A  
Homologation valid as from in group

Hersteller: Volkswagen AG Modell und Typ: Golf GTI 16 V - 19  
Manufacturer Model and type

Seite od. Nachtrag <small>Page or ext.</small>	Artikel <small>Art.</small>	Beschreibung <small>Description</small>	Photo
7	701	Federwegbegrenzung vorne - Zuganschlag - springtravel limit front - cable stop -	1
7	701	Federwegbegrenzung hinten - Zuganschlag - springtravel limit rear - cable stop -	2
7	701	Radnabe verstärkt wheel bearing housing reinforced	3
7	701	Querlenker, einstellbar, excentrisch mit Uniballgelenk wishbone adjustable eccentric with uniball joint	4

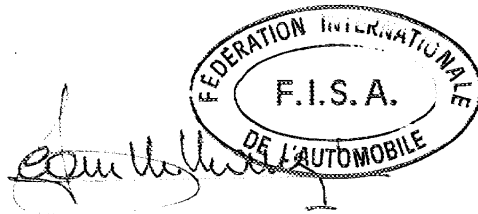



Marke Volkswagen  
Make

Modell Golf GTI 16 V  
Model

Homologations Nr. A 5295  
Homologation Nr.

Fotos  
Photos

Nachtrag Nr. 04 - 03 VO  
Ext. Nr.

1

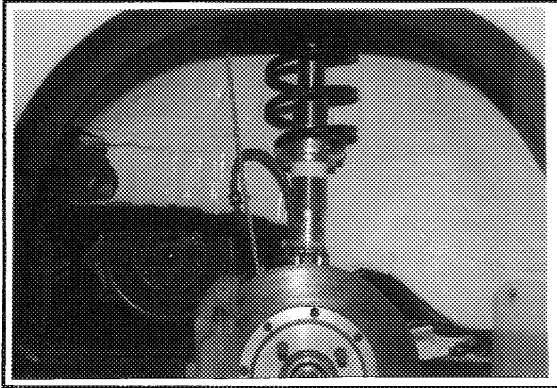

2

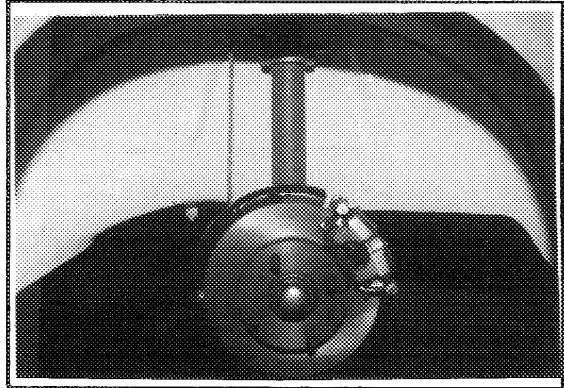

3

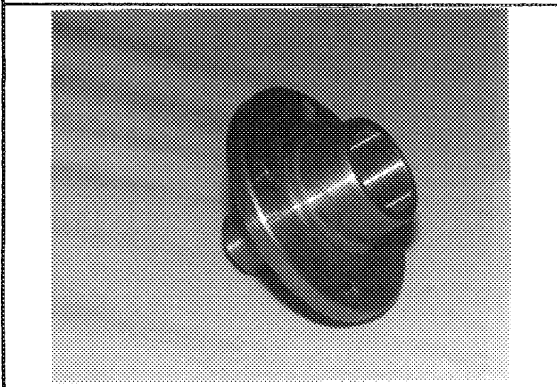

4

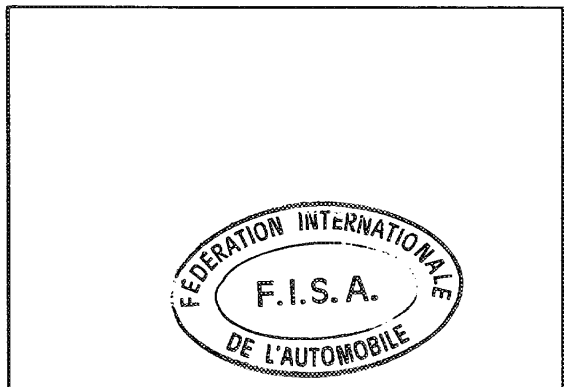
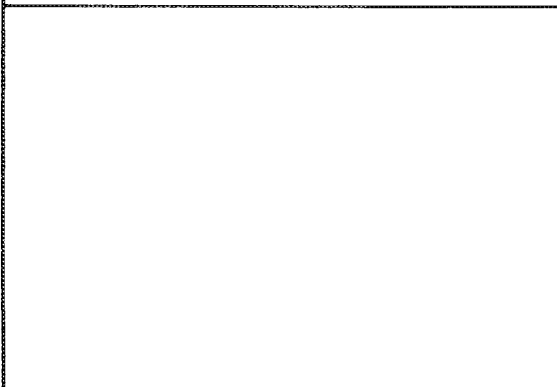
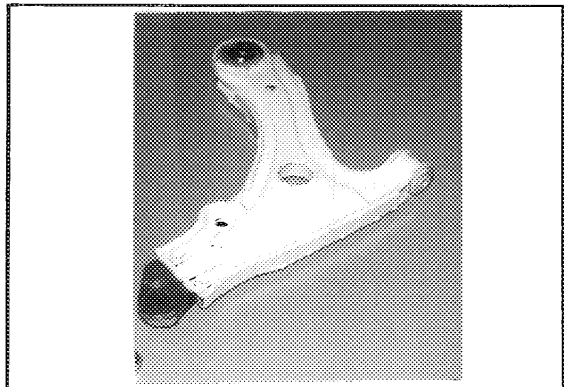



# FEDERATION INTERNATIONALE DU SPORT AUTOMOBILE

Homologation N°

**A - 5295**

Extension N°

**05 - 02 ER**

## FICHE D'EXTENSION A L'HOMOLOGATION OFFICIELLE FISA FORM OF EXTENSION TO THE OFFICIAL FISA HOMOLOGATION

- ET** Evolution normale du type: dès le numéro de châssis  
Normal evolution of the type: as from chassis number \_\_\_\_\_
- VF** Variante de fourniture / Supply variant
- VO** Variante option / Option variant
- ER** Errata / Erratum

Homologation valable dès le \_\_\_\_\_ **- 1 JAN. 1987** \_\_\_\_\_ en groupe  
Homologation valid as from \_\_\_\_\_ in group **A** \_\_\_\_\_

Constructeur VOLKSWAGEN Modèle et type GOLF GTi 16V  
Manufacturer \_\_\_\_\_ Model and type \_\_\_\_\_

Page ou ext. Page or ext.	Art. Art.	Description Description
------------------------------	--------------	----------------------------

SUPPLEMENTARY INFORMATION TO ARTICLE 803g8  
OF EXTENSION N° 02/02 VO (Page 8)

112	<b>132</b>									69
-----	------------	--	--	--	--	--	--	--	--	----

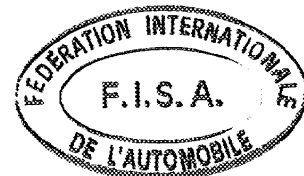

*[Handwritten signature]*

# FÉDÉRATION INTERNATIONALE DU SPORT AUTOMOBILE

ONS Oberste Nationale Sportkommission für den Automobilsport in Deutschland GmbH

Homologation Nr.

A-5295

Nachtrag Nr.  
Extension Nr.

06 / 04 VO

## Nachtrag zum offiziellen Testblatt der FISA

Form of extension to the official FISA-Homologation

- ET** Normale Weiterentwicklung des Typs: ab Fahrgestell-Nr.: \_\_\_\_\_  
Normal evolution of the type as from chassis number.
- ES** Sportevolution  
Sporting evolution
- VF** Liefervariante  
Supply variant
- VO** Ausstattungsvariante  
Option variant
- ER** Berichtigung  
Erratum

**01 AVR. 1987**

Homologation gültig ab: \_\_\_\_\_ in Gruppe: A  
Homologation valid as from: in group

Hersteller: Volkswagen AG Modell und Typ: Golf GTI 16 V  
Manufacturer Model and type

Seite od. Nachtrag <small>Page or ext.</small>	Artike: <small>Art</small>	Beschreibung <small>Description</small>
	804	Spurstange verstärkt mit geradem Gelenk (Foto 1). Track-rod reinforced with straight-lined joint (photo 1).
	701a	Verstärktes Radlagergehäuse für Querlenker mit Uniballgelenk (Foto 2). Reinforced front suspension for wishbone uniball joint (photo 2).

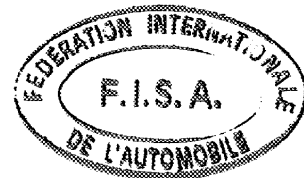

*[Handwritten signature]*

Marke Volkswagen AG  
Make

Modell Golf GTI 16 V  
Model

Homologations Nr. A-5295  
Homologation Nr.

Fotos  
Photos

Nachtrag Nr. 06/0440  
Ext. Nr.

Nr. 1

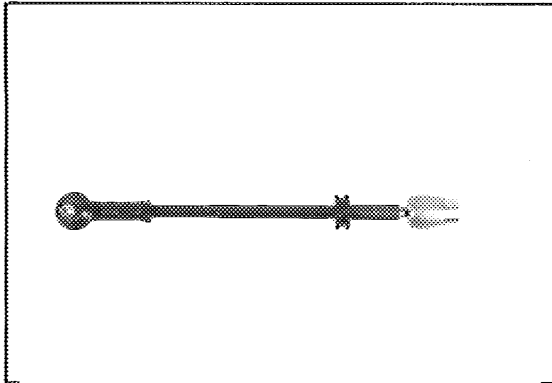

Nr. 2

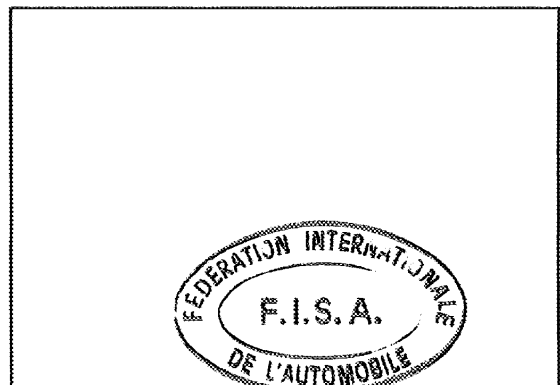
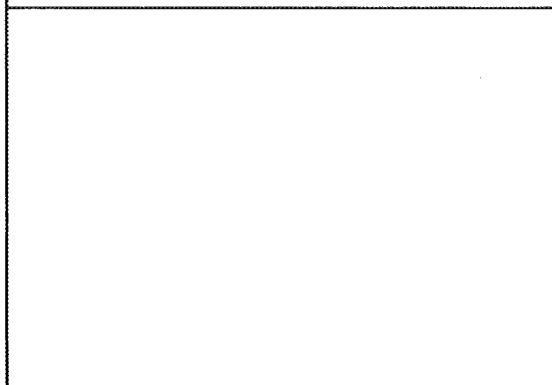
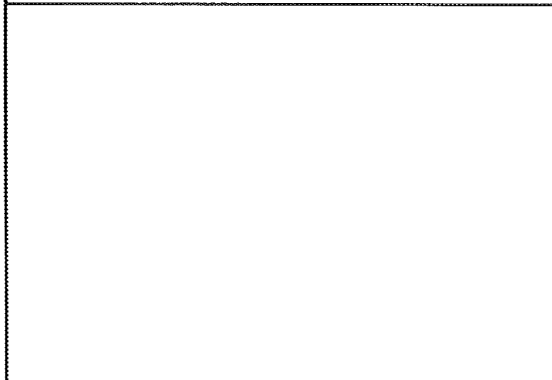
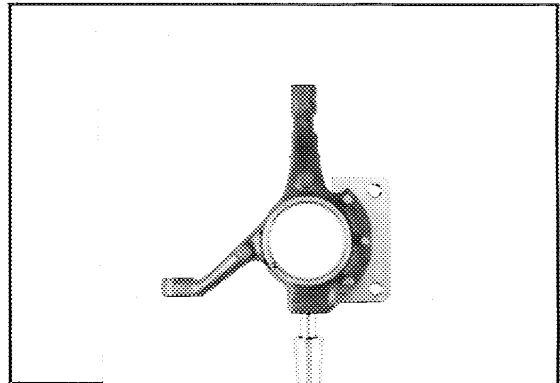



# FEDERATION INTERNATIONALE DU SPORT AUTOMOBILE

Homologation N°

A 5295

Extension N°

07 / 05 VO

FICHE D'EXTENSION A L'HOMOLOGATION OFFICIELLE FISA  
FORM OF EXTENSION TO THE OFFICIAL FISA HOMOLOGATION

- ET Evolution normale du type: dès le numéro de châssis  
Normal evolution of the type: as from chassis number \_\_\_\_\_
- VF Variante de fourniture / Supply variant
- VO Variante option / Option variant
- ER Errata / Erratum

Homologation valable dès le 01 JUIL. 1987 en groupe A  
Homologation valid as from \_\_\_\_\_ in group \_\_\_\_\_

Constructeur Volkswagen Modèle et type GTI 16V (US model)  
Manufacturer \_\_\_\_\_ Model and type \_\_\_\_\_

Page ou ext. Page or ext.	Art. Art.	Description Description
1	Photo	Front view <span style="float: right;">Photo 1</span>
4	324b	With KE-jetronic fuel injection
	324g	Fuel measuring parts: mixture control unit, metering valve en air flow meter, electronic warm up valve, injection valv encl. fuel lines, fuel pump, temperature time switch
9	804b	Steering ratio: 17.5:1
12	Photo	Injection system <span style="float: right;">Photo 2</span>

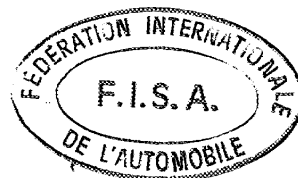

*[Handwritten signature]*

Marke Volkswagen  
Make

Modell Golf GTI 16V  
Model

Homologations Nr. A 5295  
Homologation Nr.

**07 / 0.5 V0**

Fotos  
Photos

Nachtrag Nr. \_\_\_\_\_  
Ext. Nr.

Photo 1

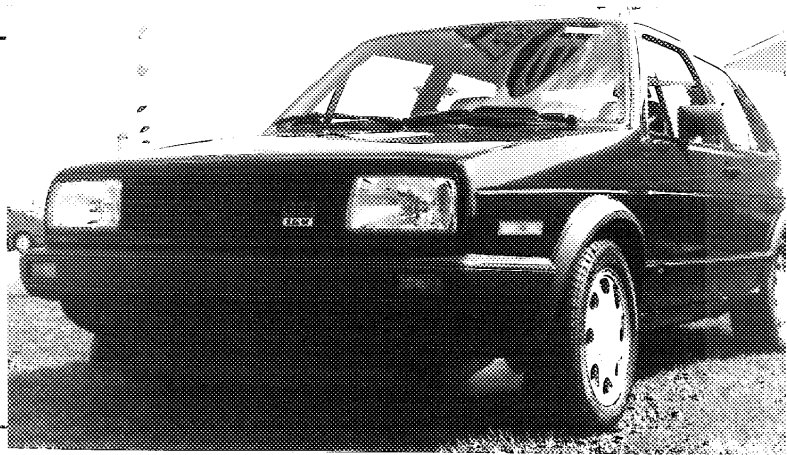
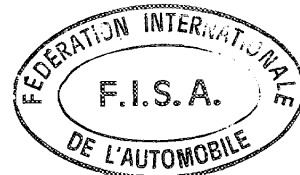
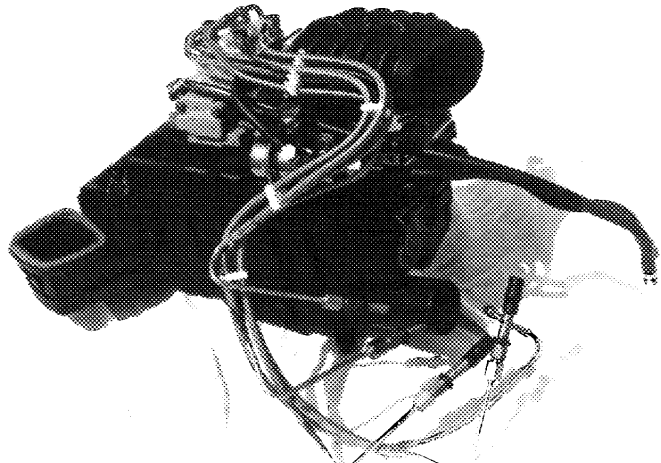

Photo 2



**FÉDÉRATION INTERNATIONALE DU SPORT AUTOMOBILE**  
**ONS Oberste Nationale Sportkommission für den Automobilsport in Deutschland GmbH**

Homologation Nr.

A 5295

Nachtrag Nr.  
 Extension Nr.

08 - 06 VO

**Nachtrag zum offiziellen Testblatt der FISA**

Form of extension to the official FISA-Homologation



- ET** Normale Weiterentwicklung des Typs: ab Fahrgestell -Nr.: \_\_\_\_\_  
Normal evolution of the type: as from chassis number:
- ES** Sportevolution  
Sporting evolution
- VF** Liefervariante  
Supply variant
- VO** Ausstattungsvariante  
Option variant
- ER** Berichtigung  
Erratum

**01 JAN. 1988**

Homologation gültig ab: \_\_\_\_\_ in Gruppe: A  
Homologation valid as from In group

Hersteller: Volkswagen AG Modell und Typ: Golf GTI 16V - 19  
Manufacturer Model and type

Seite od. Nachtrag Page or ext.	Artikel Art.	Beschreibung Description
------------------------------------	-----------------	-----------------------------

1		Photo A
		

11

- Photo E

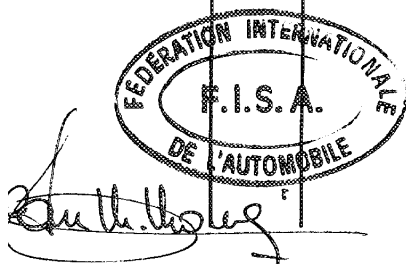

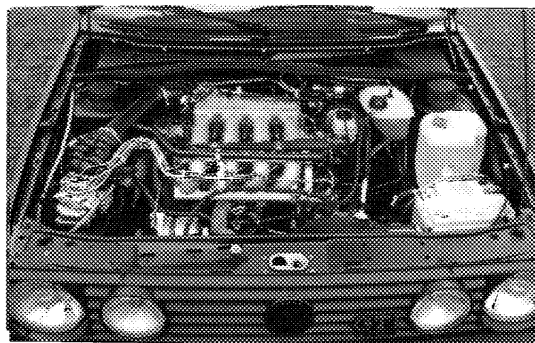

**FÉDÉRATION INTERNATIONALE DU SPORT AUTOMOBILE**  
**ONS Oberste Nationale Sportkommission für den Automobilsport in Deutschland GmbH**

Homologation Nr.

A 5295

Nachtrag Nr.  
Extension Nr.

09 - 07 VO



**Nachtrag zum offiziellen Testblatt der FISA**

Form of extension to the official FISA-Homologation

- ET** Normale Weiterentwicklung des Typs: ab Fahrgestell-Nr.: \_\_\_\_\_  
Normal evolution of the type: as from chassis number.
- ES** Sportevolution  
Sporting evolution
- VF** Liefervariante  
Supply variant
- VO** Ausstattungsvariante  
Option variant
- ER** Berichtigung  
Erratum

Homologation gültig ab: 01 JAN. 1988 in Gruppe: A  
Homologation valid as from in group

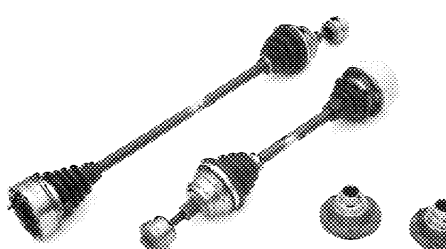
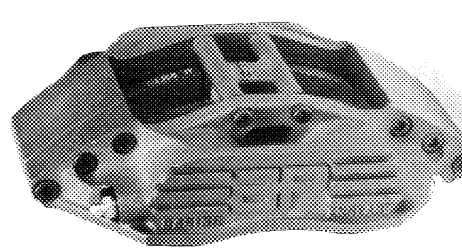
Hersteller: Volkswagen AG Modell und Typ: Golf GTI 16V - 19  
Manufacturer Model and type

Seite od. Nachtrag Page or ext.	Artikel Art.	Beschreibung Description
6	606	Verstärkte Antriebswellen reinforced drive shafts 
8	803	Bremssattel AP brake caliper AP  
7	605	Achsantrieb finaldrive b) Ratio: 3,272 c) Zähnezahl: number of teeth 72 : 22

*Handwritten signature*



Marke Volkswagen  
 Make

Modell Golf GTI 16V  
 Model

Homologations Nr. A 5295  
 Homologation Nr.

Nachtrag Nr. 09 - 07 VO  
 Ext. Nr.

Seite od. Nachtrag Page or ext.	Artikel Art.	Beschreibung Description
------------------------------------	-----------------	-----------------------------

- 8 803. Bremsen:  
Brakes.
- e) Anzahl der Zylinder je Rad  
Number of cylinders per wheel
- 1) Bohrung  
Bore
- g) Scheibenbremsen  
Disc brakes
- 1) Anzahl der Bremsbeläge je Rad  
Number of pads per wheel
- 2) Anzahl der Sättel je Rad  
Number of calipers per wheel
- 3) Material der Bremssättel  
Caliper material
- 4) Maximale Dicke der Scheibe  
Maximum disc thickness
- 5) Außendurchmesser der Scheibe  
Exterior diameter of the disc
- 6) Außendurchmesser der Belagfläche  
Exterior diameter of the shoes rubbing surface
- 7) Innendurchmesser der Belagfläche  
Interior diameter of the shoes rubbing surface
- 8) Länge der Beläge über Alles  
Overall length of the shoes
- 9) Belüftete Scheiben  
Ventilated disc
- 10) Bremsfläche je Rad  
Braking surface per wheel: qcm

Vorn Front					Hinten Rear				
4									
38,1	41,3	44,5							
2									
1									
Aluminium									
25,2	28,2	30,2	32,2	<sup>+</sup> 1,5					
280	290	295	304	<sup>+</sup> 1,5					
280	290	295	304	<sup>+</sup> 1,5					
178	188	193	202	<sup>+</sup> 1,5					
186	196	201	210	<sup>+</sup> 1,5					
132	132	132	132	<sup>+</sup> 1,5					
belüftet / ventilated									
733	765	781	810						
688	717	732	758						



**FÉDÉRATION INTERNATIONALE DU SPORT AUTOMOBILE**  
**ONS Oberste Nationale Sportkommission für den Automobilsport in Deutschland GmbH**

Homologation Nr.

A 5295

Nachtrag Nr.  
Extension Nr.

10 - 08 VO

Nachtrag zum offiziellen Testblatt der FISA  
 Form of extension to the official FISA-Homologation

- ET** Normale Weiterentwicklung des Typs; ab Fahrgesteil -Nr.: \_\_\_\_\_  
Normal evolution of the type, as from chassis number.
- ES** Sportevolution  
Sporting evolution
- VF** Liefervariante  
Supply variant
- VO** Ausstattungsvariante  
Option variant
- ER** Berichtigung  
Erratum

Homologation gültig ab: 01 AVR. 1988 in Gruppe: A  
 Homologation valid as from: \_\_\_\_\_ in group: \_\_\_\_\_

Hersteller: Volkswagen AG Modell und Typ: Golf GTI 16 V - 19  
 Manufacturer: \_\_\_\_\_ Model and type: \_\_\_\_\_

Seite od. Nachtrag Page or ext.	Artikel Art.	Beschreibung Description
------------------------------------	-----------------	-----------------------------

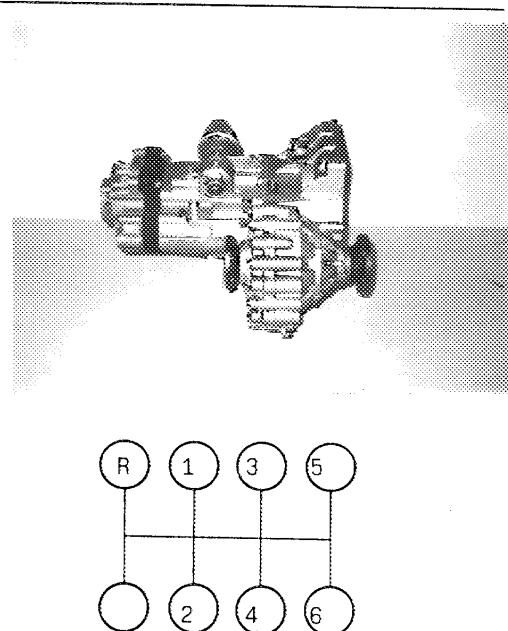
Seite od. Nachtrag Page or ext.	Artikel Art.	Beschreibung Description			
		Zusätzl. Getriebe Über- setzungen ratio	Anzahl der Zähne number of teeth	Additional G.E. SYNCHRO.	
6	603.	1	2,909	32 : 11	
		2	2,277	41 : 18	
		3	1,809	38 : 21	
		4	1,480	37 : 25	
		5	1,240	31 : 25	
		6	1,071	30 : 28	
		Rückwärts R	3,166	38 : 12	

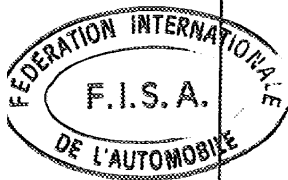

*[Handwritten signature]*



# FEDERATION INTERNATIONALE DU SPORT AUTOMOBILE

Homologation N°

A - 5295

Extension N°

11/03 ER

FICHE D'EXTENSION A L'HOMOLOGATION OFFICIELLE FISA  
FORM OF EXTENSION TO THE OFFICIAL FISA HOMOLOGATION

- ES** Evolution sportive du type / Sporting evolution of the type
- ET** Evolution normale du type / Normal evolution of the type
- VF** Variante de fourniture / Supply variant
- VO** Variante option / Option variant
- ER** Errata / Erratum

Homologation valable dès le 01 AVR. 1988 en groupe A  
Homologation valid as from \_\_\_\_\_ in group \_\_\_\_\_

Constructeur VOLKSWAGEN AG Modèle et type GOLF GTi 16 V -19  
Manufacturer \_\_\_\_\_ Model and type \_\_\_\_\_

Page ou ext. Page or ext.	Art. Art.	Description Description
3	320	Schwungrad: b) Mindestgewicht mit Anlaßzahnkranz Flywheel: Minimum weight of the flywheel with starter ring 4840 g <u>anstelle von</u> instead of 5090 g

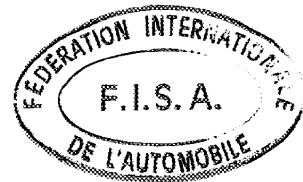

*[Handwritten signature]*

**FÉDÉRATION INTERNATIONALE DU SPORT AUTOMOBILE**  
**ONS Oberste Nationale Sportkommission für den Automobilsport in Deutschland GmbH**

Homologation Nr.

A 52 95

Nachtrag Nr.  
Extension Nr.

12 / 09 VO

Nachtrag zum offiziellen Testblatt der FISA  
 Form of extension to the official FISA-Homologation

- ET** Normale Weiterentwicklung des Typs: ab Fahrgestell-Nr.: \_\_\_\_\_  
Normal evolution of the type, as from chassis number.
- ES** Sportevolution  
Sporting evolution
- VF** Liefervariante  
Supply variant
- VO** Ausstattungsvariante  
Option variant
- ER** Berichtigung  
Erratum

Homologation gültig ab: 01 JAN 1990 in Gruppe: A  
 Homologation valid as from

Hersteller: Volkswagen AG Modell und Typ: Golf GTI 16 V  
 Manufacturer Model and type

Seite od. Nachtrag Page or ext.	Artikel Art.	Beschreibung Description	Photo
------------------------------------	-----------------	-----------------------------	-------

7	701	Querlenker vorn verstärkt mit Unibalgelenk/ Reinforced front wishbones with Unibal joints	2
7	701	Radlagergehäuse vorn verstärkt mit 4 Stehbolzen/ Reinforced front wheel bearing housings with 3 wheel studs	3
9	804	Spurstangenköpfe - Unibal, wahlweise mit Distanz- hülsen/ Track rod ends - Unibal, alternatively with spacer sleeves	4
9	804	Bolzen mit Distanzhülsen zur Befestigung des Schwenklagers/ Pins with spacer sleeves for securing the hub	5
9	901 f	Belüftung im vorderen Drittel des Daches 1 Klappe. Nur für Rallyes gültig/ One ventilation flap in front of third of roof. Only valid for rallies	6

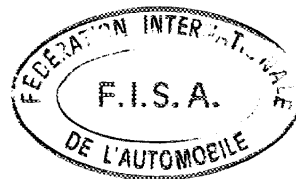

Marke Volkswagen  
Make

Modell Golf GTI 16 V  
Model

Homologations Nr. A 52 95  
Homologation Nr.

**12 / 09 VO**

Fotos  
Photos

Nachtrag Nr. \_\_\_\_\_  
Ext. Nr.

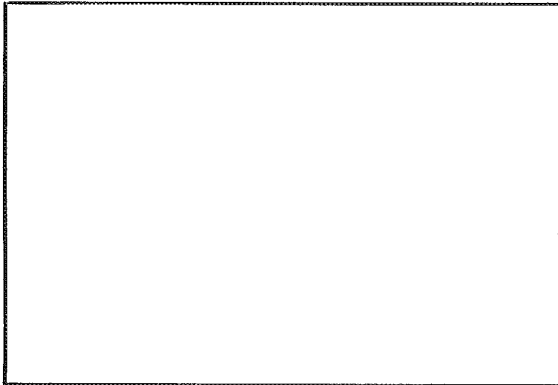

1

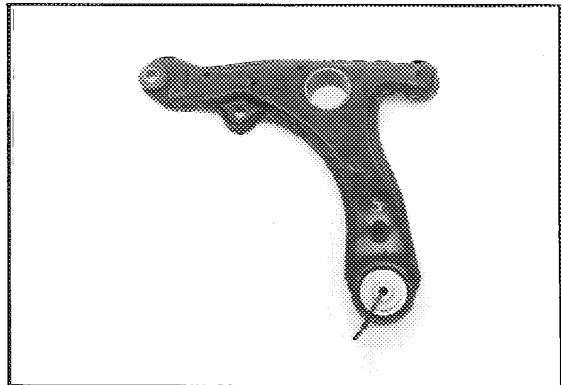

2

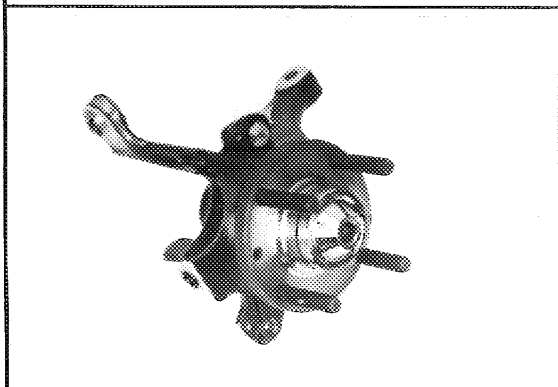

3

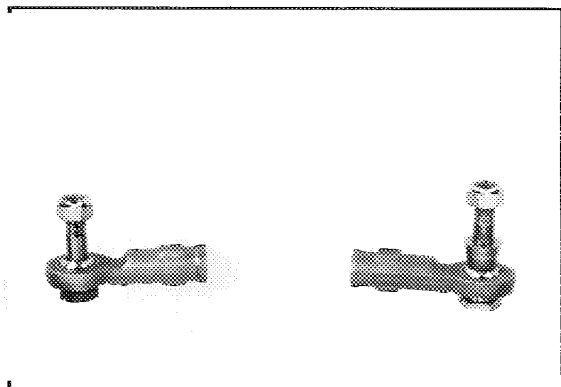

4

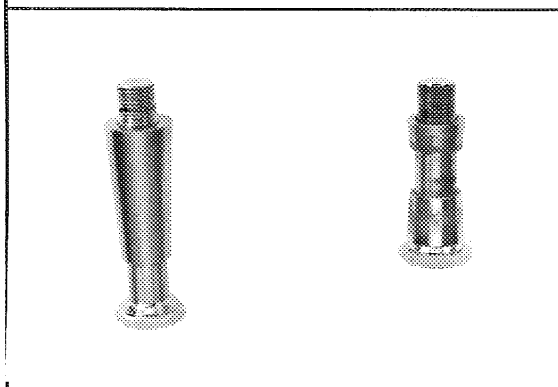

5

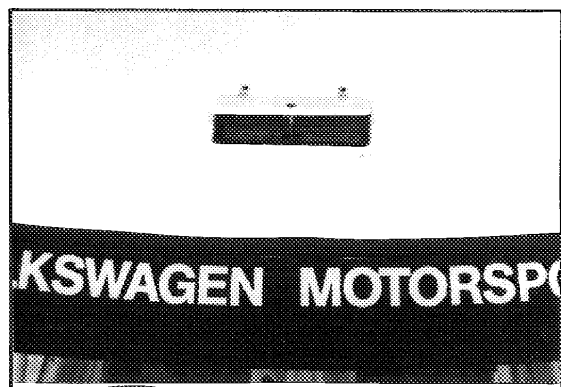

6

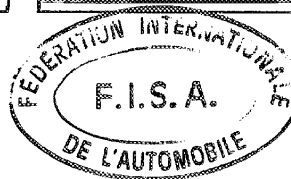

**FÉDÉRATION INTERNATIONALE DU SPORT AUTOMOBILE**  
**ONS Oberste Nationale Sportkommission für den Automobilsport in Deutschland GmbH**

Homologation Nr.

A - 5295

Nachtrag Nr.  
Extension Nr.

13 / 01 ET

**Nachtrag zum offiziellen Testblatt der FISA**  
 Form of extension to the official FISA-Homologation

- ET** Normale Weiterentwicklung des Typs: ab Fahrgestell -Nr.: 1GLW000001  
Normal evolution of the type: as from chassis number:
- ES** Sportevolution  
Sporting evolution
- VF** Liefervariante  
Supply variant
- VO** Ausstattungsvariante  
Option variant
- ER** Berichtigung  
Erratum

Homologation gültig ab: 01 JAN. 1990 in Gruppe: A  
Homologation valid as from in group

Hersteller: Volkswagen AG Modell und Typ: Golf GTI 16 V - 1 G  
Manufacturer Model and type

Seite od. Nachtrag Page or ext.	Artikel Art.	Beschreibung Description
1	Foto Photo A	 <p>Vordere Stoßstang geändert  Front bumper modified</p>
1	Foto Photo B	 <p>Hintere Stoßstange geändert  Rear bumper modified</p>



Marke Volkswagen  
Make

Modell Golf GTI 16 V  
Model

Homologations Nr. A - 5295  
Homologation Nr.

Nachtrag Nr. 13 / 01 ET  
Ext. Nr.

Seite od. Nachtrag Page or ext.	Artikel Art.	Beschreibung Description
------------------------------------	-----------------	-----------------------------

8

Bremsen:  
Brakes:

8

803 b

Anzahl der Hauptzylinder 1 Tandem b1) Bohrung 22,2 / 22,2  
Number of master cylinders Bore

8

803 e

Anzahl der Zylinder je Rad  
Number of cylinders per wheel

Vorn Front		Hinten Rear	
1		1	
54	mm	38	mm
2		2	
1		1	
Güßeisen /		cast iron	
20		10	
256 <sup>+</sup> 1mm		226 <sup>+</sup> 1mm	
253,5 <sup>±</sup> 1,5mm		224 <sup>±</sup> 1,5mm	
158,5 <sup>+</sup> 1,5mm		138 <sup>±</sup> 1,5mm	
110 <sup>±</sup> 1,5mm		76 <sup>±</sup> 1 mm	
ja/yes		nein/no	

8

803 g

Scheibenbremsen  
Disc brakes

1) Anzahl der Bremsbeläge je Rad  
Number of pads per wheel

2) Anzahl der Sättel je Rad  
Number of calipers per wheel

3) Material der Bremssättel  
Caliper material

4) Maximale Dicke der Scheibe  
Maximum disc thickness

5) Außendurchmesser der Scheibe  
Exterior diameter of the disc

6) Außendurchmesser der Belagfläche  
Exterior diameter of the shoes rubbing surface

7) Innendurchmesser der Belagfläche  
Interior diameter of the shoes rubbing surface

8) Länge der Beläge über Alles  
Overall length of the shoes

9) Belüftete Scheiben  
Ventilated disc

13

Foto  
Photo  
V

Bremse vorn  
Brake front

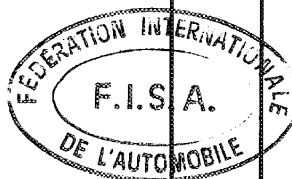
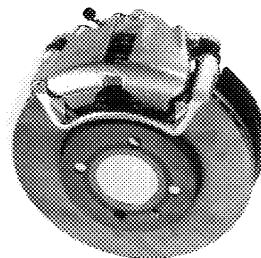

**FÉDÉRATION INTERNATIONALE DU SPORT AUTOMOBILE**  
**ONS Oberste Nationale Sportkommission für den Automobilsport in Deutschland GmbH**

Homologation Nr.

A 52 95

Nachtrag Nr.  
Extension Nr.

14 / 10

**Nachtrag zum offiziellen Testblatt der FISA**  
 Form of extension to the official FISA-Homologation

- ET** Normale Weiterentwicklung des Typs: ab Fahrgestell -Nr.: \_\_\_\_\_  
Normal evolution of the type: as from chassis number:
- ES** Sportevolution  
Sporting evolution
- VF** Liefervariante  
Supply variant
- VO** Ausstattungsvariante  
Option variant
- ER** Berichtigung  
Erratum

Homologation gültig ab: \_\_\_\_\_ **01 AVR. 1990** \_\_\_\_\_ In Gruppe: A  
 Homologation valid as from \_\_\_\_\_ In group

Hersteller: Volkswagen AG \_\_\_\_\_ Modell und Typ: Golf GTI 16 V  
 Manufacturer \_\_\_\_\_ Model and type

Seite od. Nachtrag Page or ext.	Artikel Art.	Beschreibung Description	Photo
7	701	Querlenker vorn verstärkt mit Unibalgelenk/ Reinforced front wishbones with Unibal joints	1
7	701	Radlagergehäuse vorn verstärkt mit 4 Stehbolzen/ Reinforced front wheel bearing housings with 3 wheel studs	2
9	804	Spurstangenköpfe - Unibal, wahlweise mit Distanz- hülsen/ Track rod ends - Unibal, alternatively with spacer sleeves	3
9	804	Bolzen mit Distanzhülsen zur Befestigung des Schwenklagers/ Pins with spacer sleeves for securing the hub	4

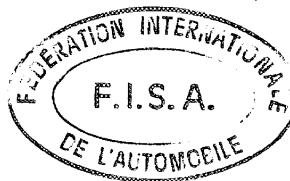



Marke Volkswagen

Modell Golf GTI 16 V

Homologations Nr. A 52 95

Photos  
photos

Homologation Nr. **14 / 10 VO**  
Nachtrag Nr. \_\_\_\_\_  
Ext. Nr. \_\_\_\_\_

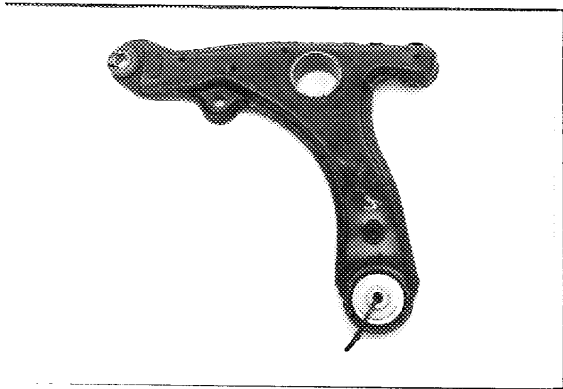

1

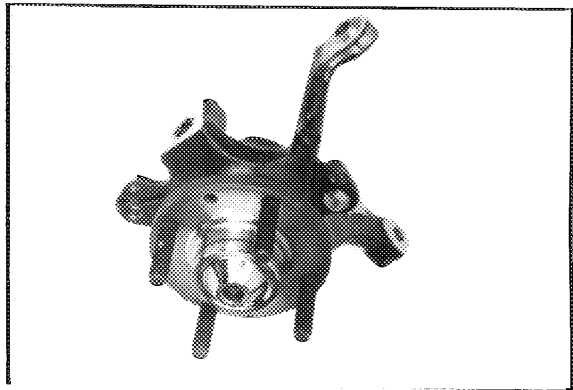

2

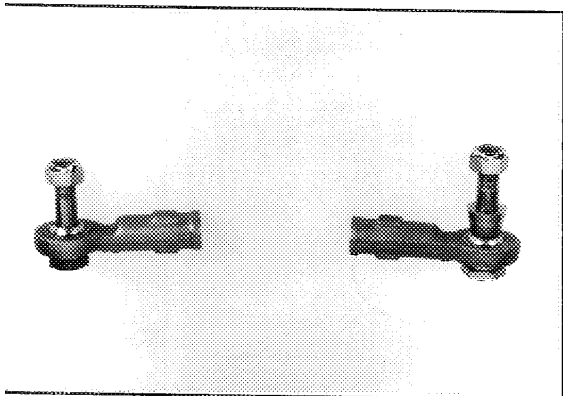

3

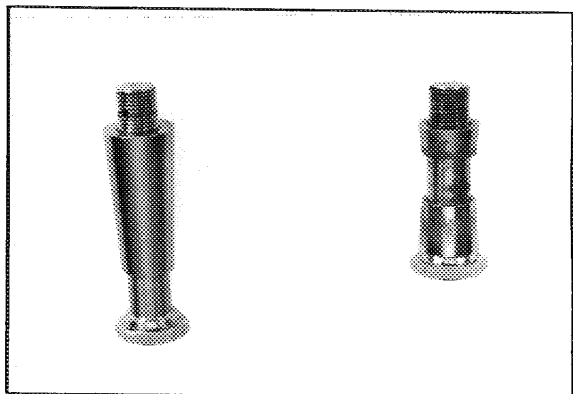

4

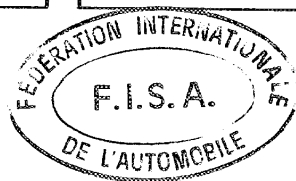
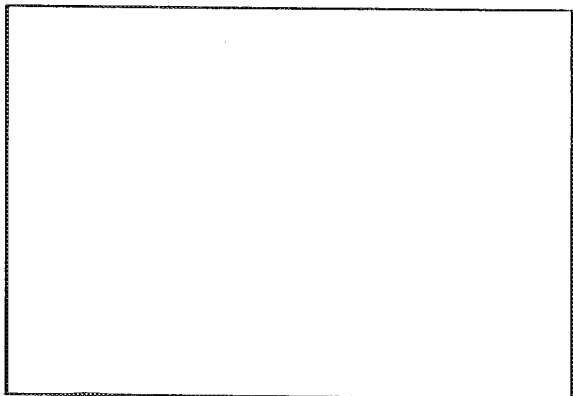
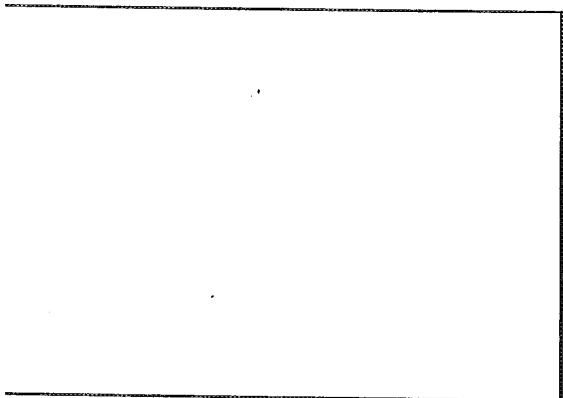

**FÉDÉRATION INTERNATIONALE DU SPORT AUTOMOBILE**  
**ONS Oberste Nationale Sportkommission für den Automobilsport in Deutschland GmbH**

Homologation Nr.

A 52 95

Nachtrag Nr.  
Extension Nr.

15 / 11 VI

**Nachtrag zum offiziellen Testblatt der FISA**  
 Form of extension to the official FISA Homologation

- ET** Normale Weiterentwicklung des Typs: ab Fahrgestell-Nr.: \_\_\_\_\_  
Normal evolution of the type: as from chassis number:
- ES** Sportevolution  
Sporting evolution
- VF** Liefervariante  
Supply variant
- VO** Ausstattungsvariante  
Option variant
- ER** Berichtigung  
Erratum

Homologation gültig ab: 01 JULI, 1990 In Gruppe: A  
Homologation valid as from In group

Hersteller: Volkswagen AG Modell und Typ: Golf GTI 16V  
Manufacturer Model and type

Seite od. Nachtrag Page or ext.	Artikel Art.	Beschreibung Description																																											
6	603.	<table border="1"> <thead> <tr> <th colspan="2">Zusätzl. Getriebe</th> <th>Additional G B</th> <th rowspan="2">Über- setzungen ratio</th> <th rowspan="2">synchro.</th> </tr> <tr> <th>Anzahl der Zähne number of teeth</th> <th></th> <th></th> </tr> </thead> <tbody> <tr> <td>1</td> <td>35 : 11</td> <td></td> <td>3,182</td> <td></td> </tr> <tr> <td>2</td> <td>32 : 14</td> <td></td> <td>2,286</td> <td></td> </tr> <tr> <td>3</td> <td>30 : 17</td> <td></td> <td>1,765</td> <td></td> </tr> <tr> <td>4</td> <td>28 : 19</td> <td></td> <td>1,474</td> <td></td> </tr> <tr> <td>5</td> <td>26 : 21</td> <td></td> <td>1,238</td> <td></td> </tr> <tr> <td>6</td> <td>24 : 23</td> <td></td> <td>1,043</td> <td></td> </tr> <tr> <td>Rück- wärts R</td> <td><math>\frac{19}{11} \times \frac{36}{20}</math></td> <td></td> <td>3,109</td> <td></td> </tr> </tbody> </table>	Zusätzl. Getriebe		Additional G B	Über- setzungen ratio	synchro.	Anzahl der Zähne number of teeth			1	35 : 11		3,182		2	32 : 14		2,286		3	30 : 17		1,765		4	28 : 19		1,474		5	26 : 21		1,238		6	24 : 23		1,043		Rück- wärts R	$\frac{19}{11} \times \frac{36}{20}$		3,109	
Zusätzl. Getriebe		Additional G B	Über- setzungen ratio	synchro.																																									
Anzahl der Zähne number of teeth																																													
1	35 : 11		3,182																																										
2	32 : 14		2,286																																										
3	30 : 17		1,765																																										
4	28 : 19		1,474																																										
5	26 : 21		1,238																																										
6	24 : 23		1,043																																										
Rück- wärts R	$\frac{19}{11} \times \frac{36}{20}$		3,109																																										

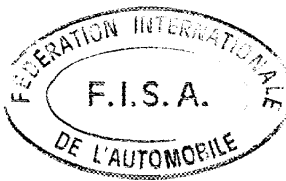
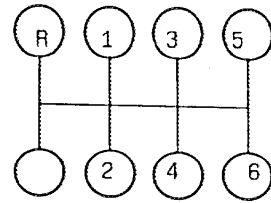

Marke Volkswagen  
Make

Modell Golf GTI 16V  
Model

Homologations Nr. A 52 95  
Homologation Nr.

Nachtrag Nr. 15 / 11 V0  
Ext. Nr.

Seite od. Nachtrag Page or ext.	Artikel Art.	Beschreibung Description	Photo
6	803	Getriebegehäuse verstärkt/ Gear-box housing reinforced	1
7	701	Federbeinlagerung verstärkt, exzentrisch, einstellbar/ Reinforced suspension strut mountings, eccentrically, adjustable	2
7	706	Stabilisator verstellbar/ Adjustable anti-roll bar: Ø 15 - 30 mm	3
8	803	Bremsbelüftung: Vorderachse/ Ø max. 10 cm Brake cooling duct: Front	4
9	804	Servolenkung mit geändertem Übersetzungsverhältnis power assisted steering with ratio 15:1	

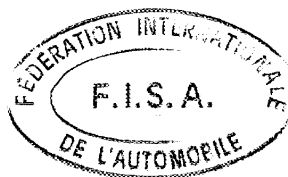

Marke Volkswagen  
Make

Modell Golf GTI 16 V  
Model

Homologations Nr. A 52 95  
Homologation Nr.

Fotos  
Photos

Nachtrag Nr. 15 / 1100  
Ext. Nr.

1

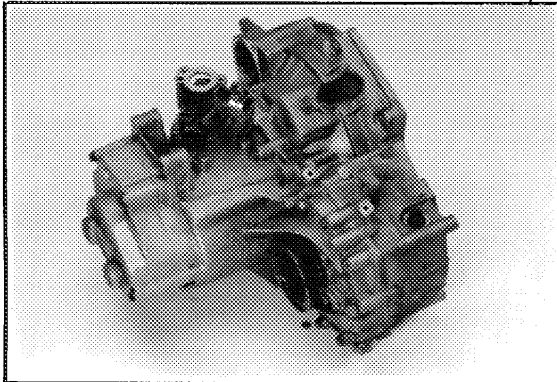

2

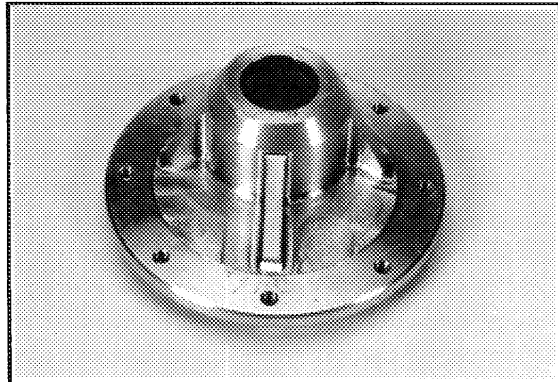

3

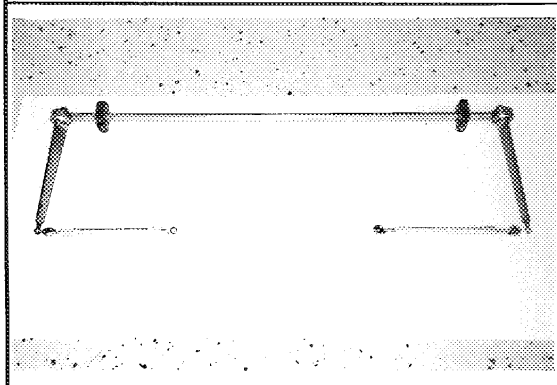

4

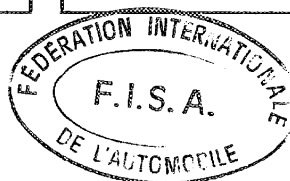
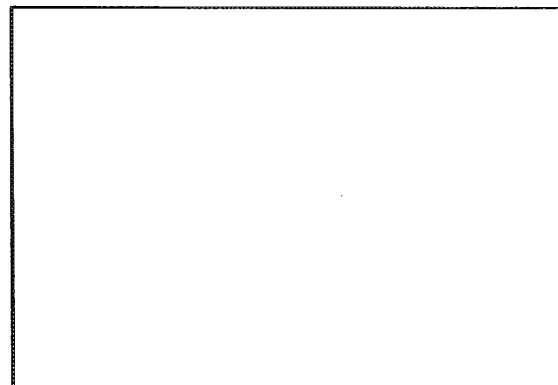
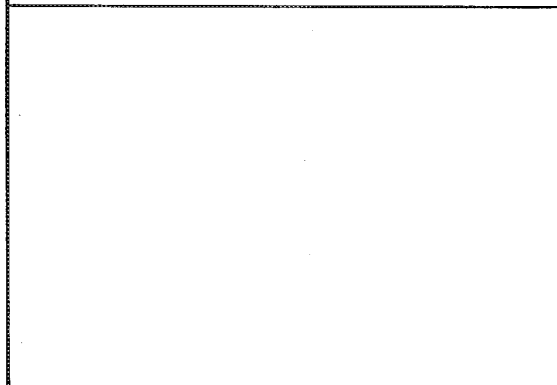
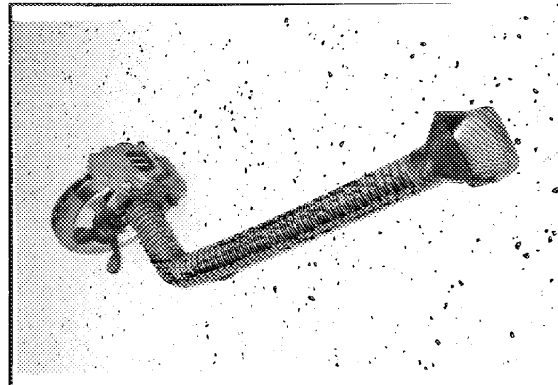

**FÉDÉRATION INTERNATIONALE DU SPORT AUTOMOBILE**  
**ONS Oberste Nationale Sportkommission für den Automobilsport in Deutschland GmbH**

Homologation Nr.

A 5295

Nachtrag Nr.  
Extension Nr.

**16 / 12 VI**

Nachtrag zum offiziellen Testblatt der FISA  
 Form of extension to the official FISA-Homologation

- ET** Normale Weiterentwicklung des Typs: ab Fahrgestell -Nr.: \_\_\_\_\_  
Normal evolution of the type: as from chassis number:
- ES** Sportevolution  
Sporting evolution
- VF** Liefervariante  
Supply variant
- VO** Ausstattungsvariante  
Option variant
- ER** Berichtigung  
Erratum

Homologation gültig ab: 01 JAN. 1991 in Gruppe: A  
 Homologation valid as from: \_\_\_\_\_ in group: \_\_\_\_\_

Hersteller: Volkswagen AG Modell und Typ: Golf GTI 16 V  
 Manufacturer: \_\_\_\_\_ Model and type: \_\_\_\_\_

Seite od. Nachtrag Page or ext.	Artikel Art.	Beschreibung Description																																		
6	603	<table border="1"> <thead> <tr> <th rowspan="2"></th> <th colspan="2">Zusätzl. Getriebe Additional G B</th> <th rowspan="2">synchro.</th> </tr> <tr> <th>Über- setzungen ratio</th> <th>Anzahl der Zähne number of teeth</th> </tr> </thead> <tbody> <tr> <td>1</td> <td>2,900</td> <td>29/10</td> <td></td> </tr> <tr> <td>2</td> <td>2,267</td> <td>34/15</td> <td></td> </tr> <tr> <td>3</td> <td>1,800</td> <td>36/20</td> <td></td> </tr> <tr> <td>4</td> <td>1,458</td> <td>35/24</td> <td></td> </tr> <tr> <td>5</td> <td>1,214</td> <td>34/28</td> <td></td> </tr> <tr> <td>6</td> <td>1,036</td> <td>29/28</td> <td></td> </tr> <tr> <td>Rück- wärts R</td> <td>2,880</td> <td><math>\frac{16}{10} \times \frac{36}{20}</math></td> <td></td> </tr> </tbody> </table> <p style="text-align: right;"><u>ONLY VALID FOR 13/01 ET</u></p>		Zusätzl. Getriebe Additional G B		synchro.	Über- setzungen ratio	Anzahl der Zähne number of teeth	1	2,900	29/10		2	2,267	34/15		3	1,800	36/20		4	1,458	35/24		5	1,214	34/28		6	1,036	29/28		Rück- wärts R	2,880	$\frac{16}{10} \times \frac{36}{20}$	
	Zusätzl. Getriebe Additional G B			synchro.																																
	Über- setzungen ratio	Anzahl der Zähne number of teeth																																		
1	2,900	29/10																																		
2	2,267	34/15																																		
3	1,800	36/20																																		
4	1,458	35/24																																		
5	1,214	34/28																																		
6	1,036	29/28																																		
Rück- wärts R	2,880	$\frac{16}{10} \times \frac{36}{20}$																																		

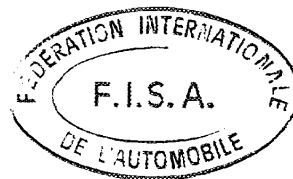

*[Signature]*  
Seite (Page) 1/1

Marke Volkswagen  
 Make

Modell Golf GTi 16 V  
 Model

Homologations Nr. A 5295  
 Homologation Nr.

**16 / 12 VC**

Nachtrag Nr. \_\_\_\_\_  
 Ext. Nr.

Seite od. Nachtrag Page or ext.	Artikel Art.	Beschreibung Description	Foto Photo
6	605	Achsantrieb Finaldrive b) Übersetzungs- verhältnis Ratio 4,615 - 4,462 - 4,214 - 4,071 - 3,867 - 3,733 - 3,563 - 3,438 - 3,294 - 3,176 - 3,056 c) Anzahl der Zähne Number of teeth 60/13 - 58/13 - 59/14 - 57/14 - 58/15 - 56/15 - 57/16 - 55/16 - 56/17 - 54/17 - 55/18	
5	602 b	Kupplung Cluth b) Art der Betätigung: Drive system: hydraulisch hydraulic	
7	701	Querlenker vorn verstärkt mit Unibalgelenken Reinforced front wishbones with unibaljoints	1
7	706	Stabilisator - einstellbar vorn und hinten Adjustable anti-roll bar front and rear	2
8	803	Schutzblech für Bremsscheibe Protection plate for brake caliper	3



Marke Volkswagen  
Make

Modell Golf GTi 16 V  
Model

Homologations Nr. A 5295  
Homologation Nr.

Fotos  
Photos

Nachtrag Nr. 16 / 12 VO  
Ext. Nr.

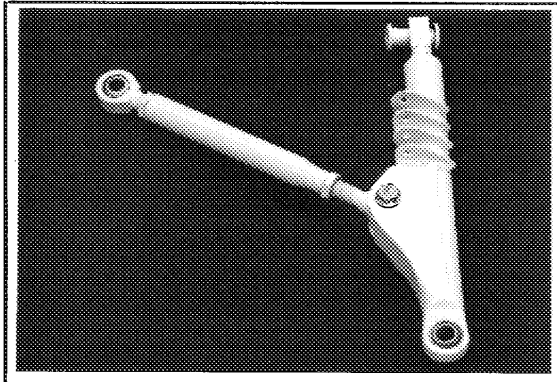

1

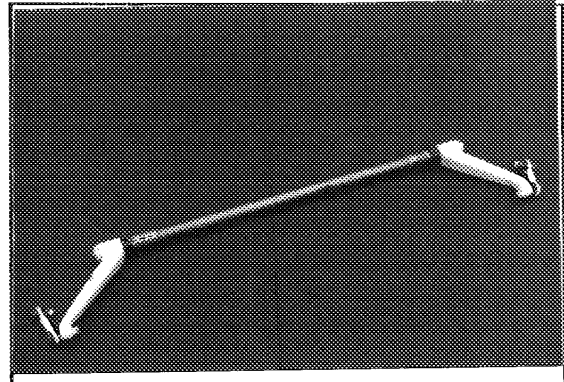

2

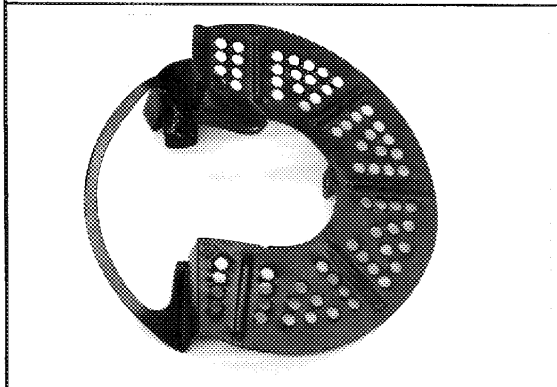

3

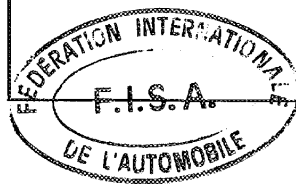
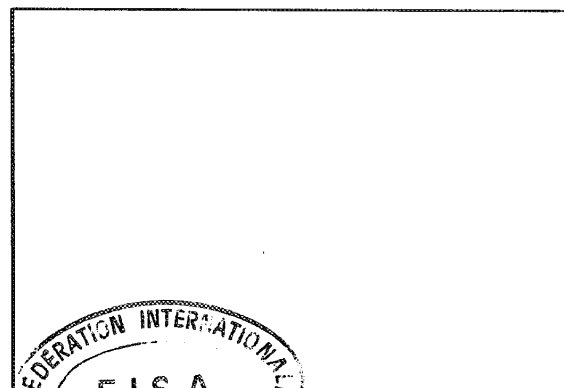
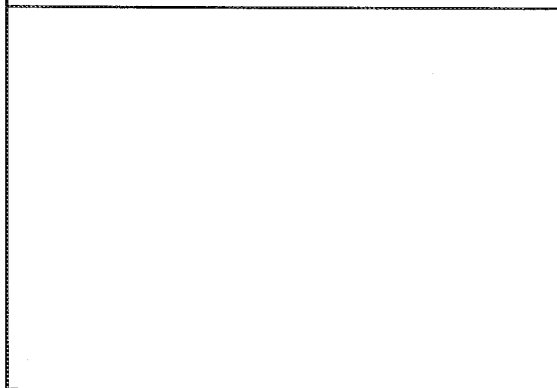
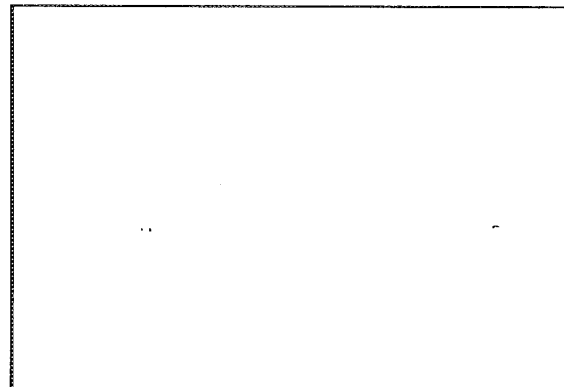

# FÉDÉRATION INTERNATIONALE DU SPORT AUTOMOBILE

ONS Oberste Nationale Sportkommission für den Automobilsport in Deutschland GmbH

Homologation Nr.

A - 5295

Nachtrag Nr.  
Extension Nr.

17 / 13 VO

## Nachtrag zum offiziellen Testblatt der FISA

Form of extension to the official FISA Homologation

- ET** Normale Weiterentwicklung des Typs: ab Fahrgestell-Nr.: \_\_\_\_\_  
Normal evolution of the type: as from chassis number
- ES** Sportevolution  
Sporting evolution
- VF** Liefervariante  
Supply variant
- VO** Ausstattungsvariante  
Option variant
- ER** Berichtigung  
Erratum

Homologation gültig ab: 01 JAN. 1991 in Gruppe: A  
Homologation valid as from: \_\_\_\_\_ in group: \_\_\_\_\_

Hersteller: Volkswagen AG Modell und Typ: Golf GTi 16 V  
Manufacturer: \_\_\_\_\_ Model and type: \_\_\_\_\_

Seite od. Nachtrag Page or ext.	Artikel Art	Beschreibung Description	Foto Photo
6	603	Schaltbetätigung mit Seilzügen verstärkt auf Tunnel / Reinforced gearshift linkage, with cables, mounted on the tunnel	1
7	701	Federbeinlagerung verstärkt, exzentrisch, einstell- bar / Reinforced suspension strut mountings, excentrically adjustable	2
7	701	Radlagergehäuse vorn verstärkt - Aluminium / Reinforced front wheel bearing housings - aluminium	3
7	701	Querlenker vorn verstärkt mit Unibalgelenken / Reinforced front wishbones with Unibal joints	4
7	701	Stabilisator verstellbar / Adjustable anti-roll bar	5
8	803	Bremssattel hinten / Brake caliper rear	6
8	803	Bremssattel vorn / Brake caliper front	7 + 8

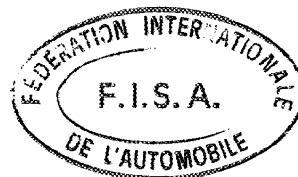

*[Handwritten signature]*



Marke Volkswagen  
Make

Modell Golf Gi 16 V  
Model

Homologations Nr. A - 5295  
Homologation Nr.

Nachtrag Nr. **17 / 13 VO**  
Ext. Nr.

Seite od. Nachtrag Page or ext	Artikel Art	Beschreibung Description	Foto Photo
8	803	Bremsscheibe vorn / Disk brake front	9
8	803	Bremsscheibe hinten / Disk brake rear	10
8	803	Bremsscheibentopf vorn / Disk brake mounting front	11 + 12
8	803	Bremsscheibentopf hinten / Disk brake mounting rear	13
8	803	Verstärkter Halter für Bremssattel / Reinforced mounting for brake caliper	14

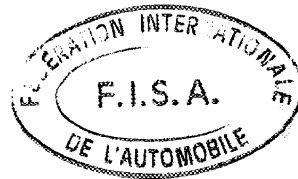

Marke VOLKSWAGEN

Modell Golf GTi 16 V

Homologations Nr. A - 5295

**17 / 13 VO**

Nachtrag Nr. 17 / 13 VO  
Ext. Nr.

Bitte <del>den</del> Nachtrag angeben	Artikel Art.	Beschreibung Description
		VERSION BREMBO

33. Bremsen:  
Brakes:

	Vorn Front	Hinten Rear
e) Anzahl der Zylinder je Rad Number of cylinders per wheel	4	2
f) Bohrung Bore	von/from 34 mm bis/to 46 mm	
Scheibenbremsen Disc brakes	2	2
1) Anzahl der Bremsbeläge je Rad Number of pads per wheel		
2) Anzahl der Sättel je Rad Number of calipers per wheel	1	1
3) Material der Bremssättel Caliper material	Aluminium	Aluminium
4) Maximale Dicke der Scheibe Maximum disc thickness	von/from 24 mm bis/to 33 mm	von/from 10 mm bis/to 22 mm
5) Außendurchmesser der Scheibe +/- 1.5 mm Exterior diameter of the disc	280   290   295   305   320   332	260   266   280
6) Außendurchmesser der Belagfläche +/- 1.5 mm Exterior diameter of the shoes rubbing surface	280   290   295   305   320   332	260   266   280
7) Innendurchmesser der Belagfläche +/- 1.5 mm Interior diameter of the shoes rubbing surface	186   186   196   202   217   229	154   160   174
8) Länge der Beläge über Alles Overall length of the shoes +/- 1.5 mm	132	76,5
9) Belüftete Scheiben Ventilated disc	ja/yes	nein/no

Bremsscheiben vorne und hinten wahlweise: glatt, genutet, gebohrt  
Brake discs front and rear may be: even, grooved, cross drilled

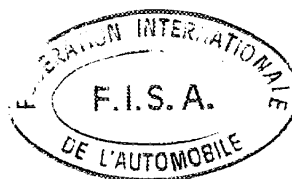

Marke VOLKSWAGEN  
Make

Modell Golf GTi 16 V  
Model

Homologations Nr. A - 5295  
Homologation Nr.

Fotos  
Photos

Nachtrag Nr. 17 / 13 VO  
Ext. Nr.

1

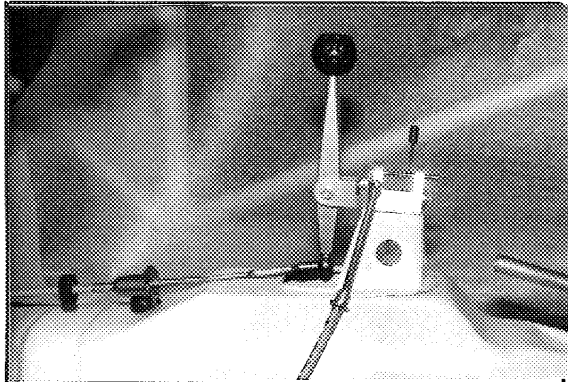

2

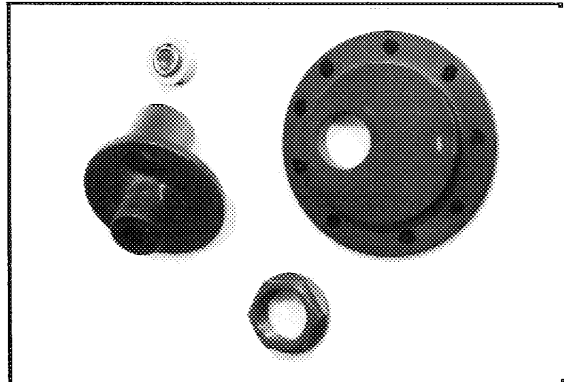

3

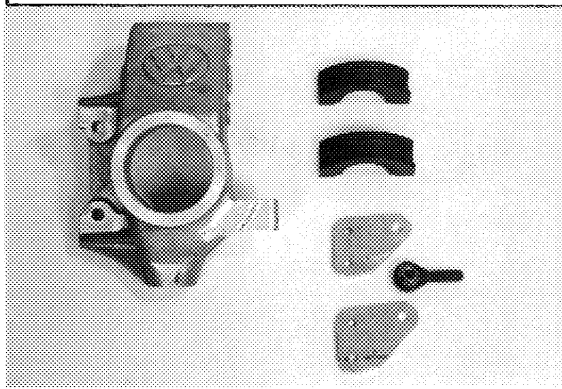

4

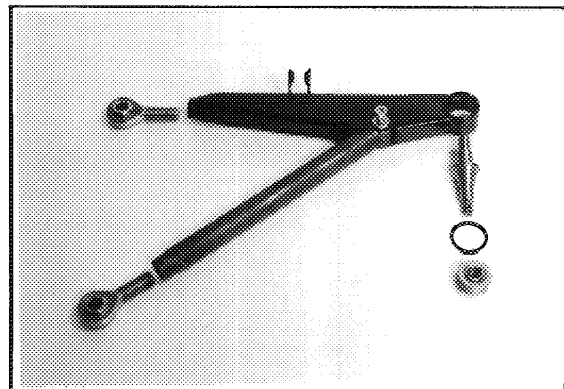

5

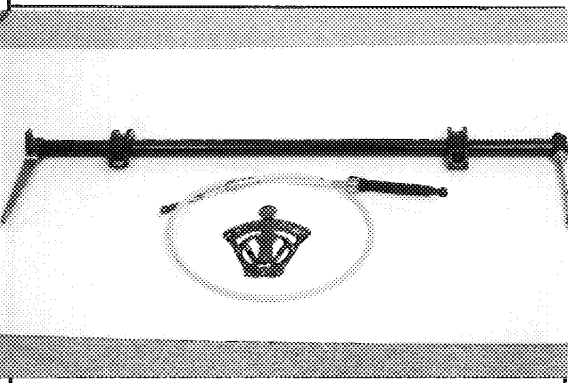

6

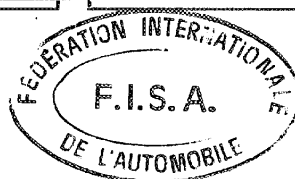
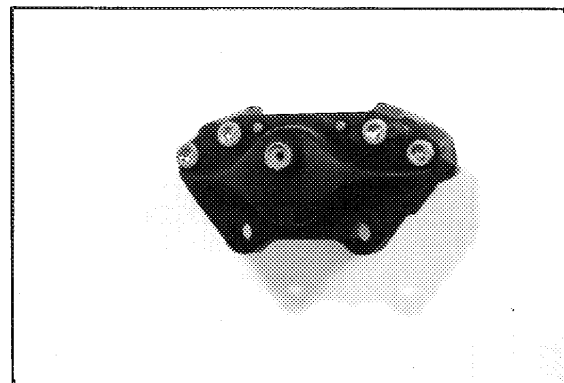

Marke VOLKSWAGEN  
Make

Modell Golf GTi 16 V  
Model

Homologations Nr. A - 5295  
Homologation Nr.

Fotos  
Photos

Nachtrag Nr. 17 / 13 V0  
Ext. Nr.

7

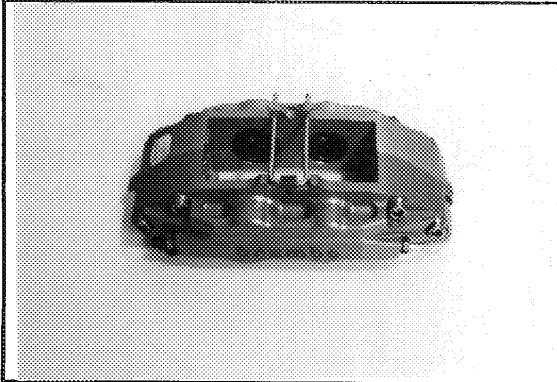

8

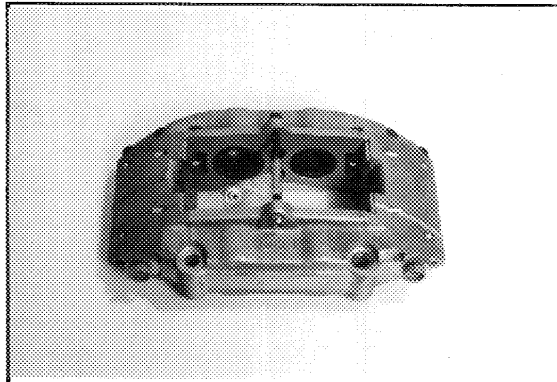

9

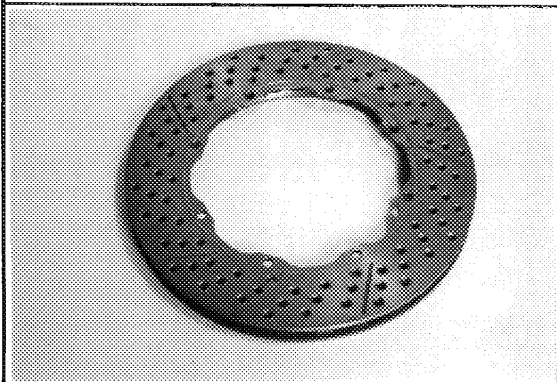

10

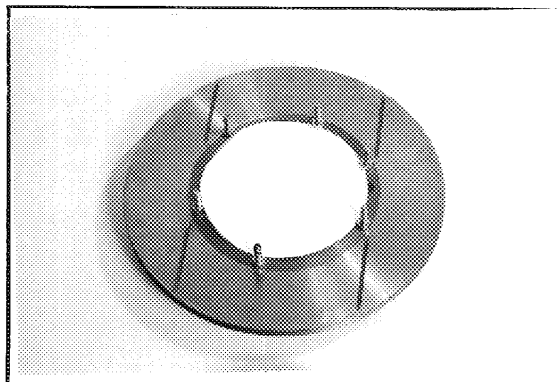

11

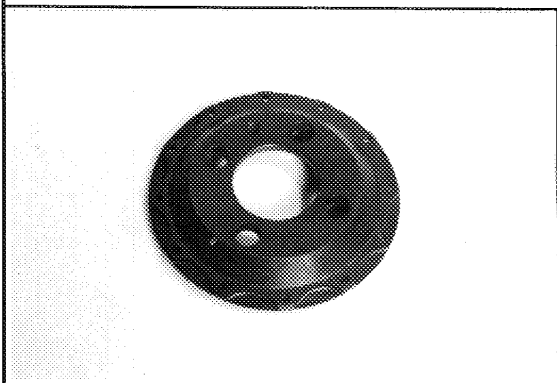

12

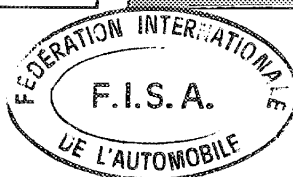
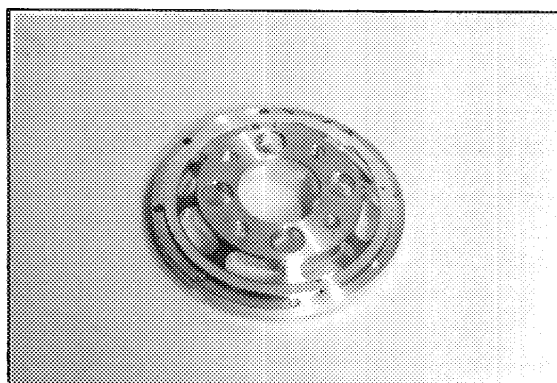

Marke VOLKSWAGEN  
Make

Modell Golf GTi 16 V  
Model

Homologations Nr. A - 5295  
Homologation Nr.

**17 / 13 VO**

Fotos  
Photos

Nachtrag Nr. \_\_\_\_\_  
Ext. Nr.

13

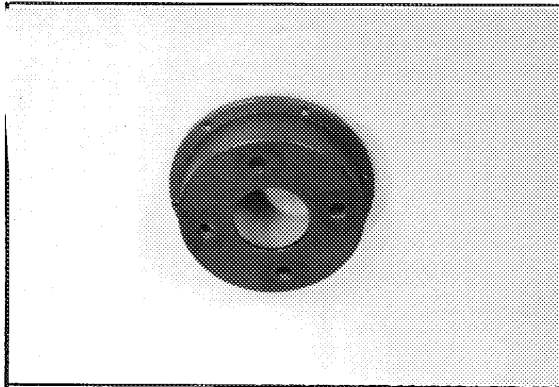

14

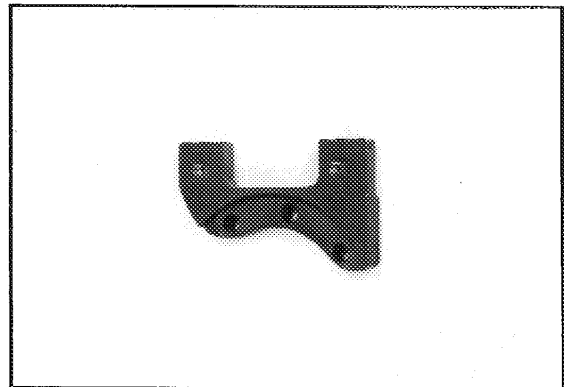

15

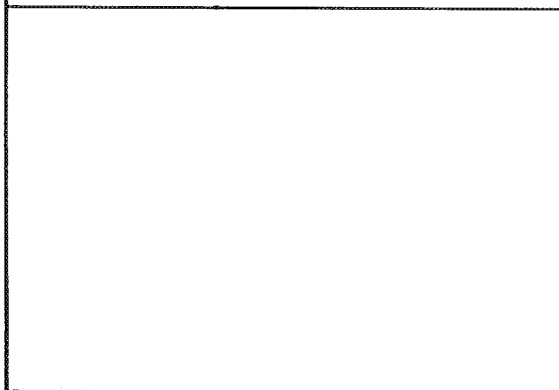

16

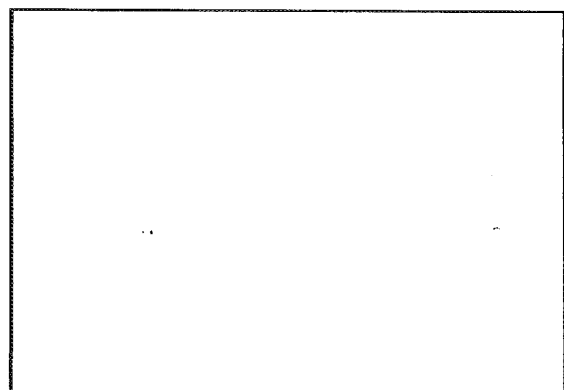

17

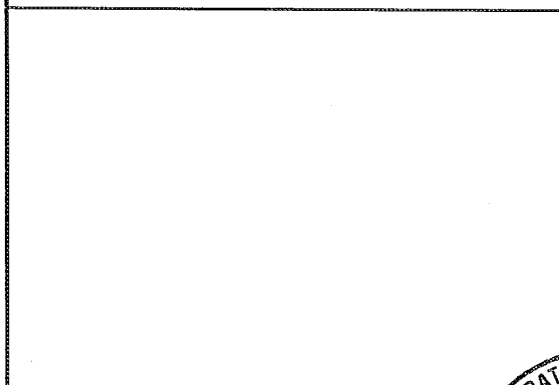

18

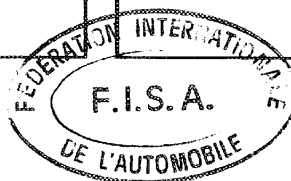
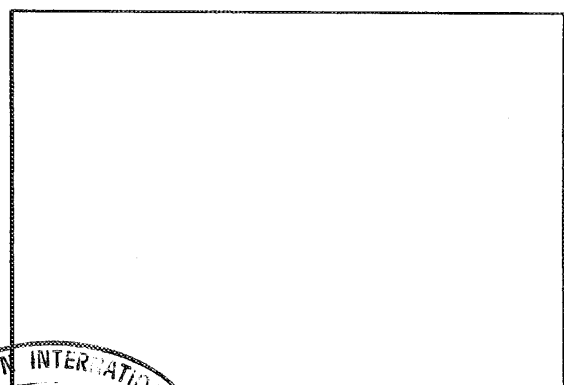

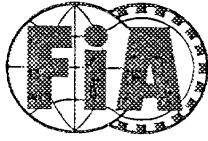

FEDERATION INTERNATIONALE  
DU SPORT AUTOMOBILE

Homologation

A-5295

Groupe A  
Group

Extension

18 / 04 ER

FICHE D'EXTENSION D'HOMOLOGATION  
FORM OF HOMOLOGATION EXTENSION

- ES Evolution sportive du type / Sporting evolution of the type       VO Variante option / Option variat
- ET Evolution normale du type / Normal evolution of the type       ER Erratum / Erratum
- VF Variante de fourniture / Supply variant

Véhicule: Constructeur VOLKSWAGEN      Modèle et type 19 GOLF GTi 16V  
Vehicle: Manufactureur      Model and type

Homologation valable à partir du 01/01/92  
Homologation valid as from

Page ou ext. Page or ext.	Article Article	Description Description
01/01	VO	L'homologation des arceaux en aluminium ou alliage léger est supprimée. The homologation of aluminium or light alloy rollcages is cancelled.

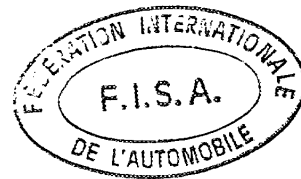

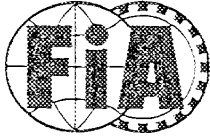

FEDERATION INTERNATIONALE  
DU SPORT AUTOMOBILE

Homologation N°

A - 5295

Groupe / Group A/B/N/T1

Extension N°

19 / 05 ER

FICHE D'EXTENSION D'HOMOLOGATION  
FORM OF HOMOLOGATION EXTENSION

- ES Evolution sportive du type / Sporting evolution of the type       VO Variante option / Option variant
- ET Evolution normale du type / Normal evolution of the type       ER Erratum / Erratum
- VF Variante de fourniture / Supply variant

Véhicule: Constructeur / Vehicle: Manufactureur VOLKSWAGEN AG      Modèle et type / Model and type 19 Golf GTI 16 V

Homologation valable à partir du / Homologation valid as from 01 JUL. 1992

Page ou ext. Page or ext.	Article Article	Description Description
13/01 ET	202	4040 instead of 3987
	209a	840 instead of 807
	209b	725 instead of 705

(C) F.I.S.A. - FC - 1990 - 01001/11/050

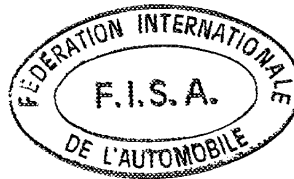

FEDERATION INTERNATIONALE DE L'AUTOMOBILE

CERTIFICAT DE PRODUCTION  
PRODUCTION CERTIFICATE

A-5295

Constructeur Volkswagen AG Date 10.03.1986  
 Manufacturer .....  
 Modèle de voiture Golf GTI 16V Type ou désignation commerciale  
 Car Model ..... Type or commercial designation  
 N° d'homologation ..... 19 E  
 Homologation N° .....  
 Nature de l'extension .....  
 Nature of the extension .....

PRODUCTION

Je soussigné certifie que la production mentionnée ci-contre s'entend pour des voitures entièrement terminées, identiques et conformes à la fiche d'homologation présentée pour ce modèle.

I hereby certify that the production indicated opposite concerns cars which are entirely completed, identical and in conformity with the recognition form submitted for the said model.

*H. Schwittlinsky*  
 Signature H. Schwittlinsky .....  
 Fonction Produktmarketing .....  
 Position VOLKSWAGEN AG

Mois/Année Month/Year		Nombre Number
1	Nov. 85	70
2	Dez. 85	159
3	Jan. 86	1822
4	Feb. 86	2130
5	März 86	860
6		
7		
8		
9		
10		
11		
12		
TOTAL		5041
Observations : Remarks :		Group A

10.03.86



CERTIFICAT DE PRODUCTION

PRODUCTION CERTIFICATE

Constructeur Volkswagen AG  
 Manufacturer .....

Date 09.05.1987 .....

Modèle de voiture Golf GTI 16V  
 Car Model .....

Type ou désignation commerciale  
 Type or commercial designation  
 ..... 19 E

No d'homologation A 5295  
 Homologation No .....

Nature de l'extension Variante Option  
 Nature of the extension .....

PRODUCTION

Je soussigné certifie que la production mentionnée ci-contre s'entend pour des voitures entièrement terminées, identiques et conformes à la fiche d'homologation présentée pour ce modèle.

*I hereby certify that the production indicated opposite concerns cars which are entirely completed, identical and in conformity with the recognition form submitted for the said model.*

	Mois / Année Month / Year	Nombre Number
1	Jan. 1987	446
2	Feb. 1987	1.027
3	März 1987	1.447
4	April 1987	1.450
5	Mai 1987	695
6		
7		
8		
9		
10		
11		
12		
	TOTAL	5.065

Signature   
 H. Schwittlinsky  
 Fonction **VOLKSWAGEN AG**  
 Position Produktmarketing VW

Observations : V0 US-Version  
 Remarks :

CERTIFICAT DE PRODUCTION

PRODUCTION CERTIFICATE

Constructeur ..... Volkswagen AG .....  
 Manufacturer

Date ..... 06.11.1987 .....

Modèle de voiture Golf GTI 16V .....  
 Car Model

Type ou désignation commerciale .....  
 Type or commercial designation ..... 19 .....

No d'homologation N + A 5291 .....  
 Homologation No

Nature de l'extension V0 - option variant .....  
 Nature of the extension

PRODUCTION

Je soussigné certifie que la production mentionnée  
 ci-contre s'entend pour des voitures entièrement  
 terminées, identiques et conformes à la fiche  
 d'homologation présentée pour ce modèle.

*I hereby certify that the production indicated  
 opposite concerns cars which are entirely  
 completed, identical and in conformity with the  
 recognition form submitted for the said model.*

Mois / Année Month / Year	1987	Nombre Number
------------------------------	------	------------------

1		
2		
3		
4		
5		
6		
7	Juli	710
8	August	2490
9	September	2973
10		
11		
12		
TOTAL		6173

Signature .....  .....

Fonction ..... Produktmarketing VW Pkw .....  
 Position ..... VOLKSWAGEN AG .....

Observations :  
 Remarks : front and rear view

FEDERATION INTERNATIONALE DE L'AUTOMOBILE

CERTIFICAT DE PRODUCTION  
PRODUCTION CERTIFICATE

Constructeur ...Volkswagen AG..... Date .....05.12.1989.....  
 Manufacturer  
 Modèle de voiture ..Golf.GTI.16.V..... Type ou désignation commerciale  
 Car Model Type or commercial designation  
 N° d'homologation ..A/N.- 5295..... 1 G.....  
 Homologation N°  
 Nature de l'extension ..Normal evolution..... 13/01 II.....  
 Nature of the extension

PRODUCTION

	Mois/Année Month/Year	Nombre Number
Je soussigné certifie que la production mentionnée ci-contre s'entend pour des voitures entièrement terminées, identiques et conformes à la fiche d'homologation présentée pour ce modèle.	1	
	2	
	3	
	4	
I hereby certify that the production indicated opposite concerns cars which are entirely completed, identical and in conformity with the homologation form submitted for the said model.	5	
	6	
	7	
	8 Aug. 1989	968
	9 Sep. 1989	2016
	10 Okt. 1989	2991
Signature .. <i>S. Sittler</i> .....	11	
Fonction Produktmarketing. VW. Pkw... Position	12	
<b>VOLKSWAGEN AG</b>	TOTAL	5975
Observations : Remarks :		Front bumper, Brakes