



FEDERATION INTERNATIONALE DU SPORT AUTOMOBILE

Homologation N°

B - 2 1 4

Groupe **A/B**
Group

FICHE D'HOMOLOGATION CONFORME A L'ANNEXE J DU CODE SPORTIF INTERNATIONAL
HOMOLOGATION FORM IN ACCORDANCE WITH APPENDIX J OF THE INTERNATIONAL SPORTING CODE

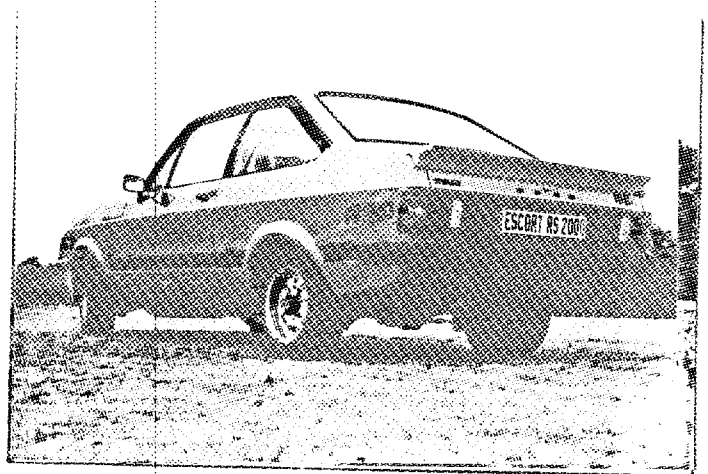
Homologation valable à partir du
Homologation valid as from 1 JUM 1982

en groupe B
in group

Photo A

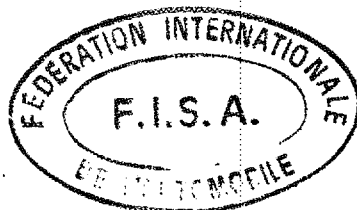


Photo B



1. DEFINITIONS / DEFINITIONS

101. Constructeur
Manufacturer FORD MOTOR CO LTD
102. Dénomination(s) commerciale(s) — Modèle et type
Commercial name(s) — Type and model Escort RS2000 B
103. Cylindrée totale
Cylinder capacity 1993 cm³
104. Mode de construction
Type of car construction
 séparée, matériau du châssis
 separate, material of chassis Steel
 monocoque
 unitary construction
105. Nombre de volumes
Number of volumes 3
106. Nombre de places
Number of places 4



Marque FORD Modèle RS2000 N° Homol. B-214
 Make _____ Model _____

2. DIMENSIONS, POIDS / DIMENSIONS, WEIGHT

202. Longueur hors-tout 4150 mm ± 1%
 Overall length _____

203. Largeur hors-tout 1607 mm ± 1% Endroit de la mesure At door handles
 Overall width _____ Where measured _____

204. Largeur de la carrosserie: a) A la hauteur de l'axe AV 1565 mm ± 1%
 Width of bodywork: At front axle _____
 b) A la hauteur de l'axe AR 1600 mm ± 1%
 At rear axle _____

208. Empattement: a) Droit 2407 mm ± 1% b) Gauche: 2407 mm ± 1%
 Wheelbase: Right _____ Left _____

209. Porte-à-laux: a) AV: 822 mm ± 1% b) AR: 921 mm ± 1%
 Overhang: Front: _____ Rear: _____

210. Distance «G» (volant — paroi de séparation AR) 1490 mm ± 1%
 Distance «G» (steering wheel — rear bulkhead) _____

3. MOTEUR / ENGINE: (En cas de moteur rotatif, voir Article 335 sur fiche complémentaire).
 (In case of rotative engine, see Article 335 on complementary form).

301. Emplacement et position du moteur: Front, Longitudinal, vertical
 Location and position of the engine: _____

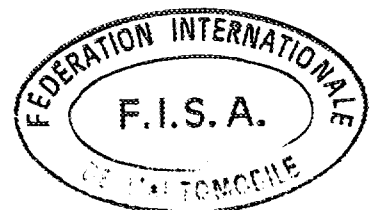
303. Cycle 4 stroke
 Cycle _____

304. Suralimentation /non; type No
 Supercharging /no; type _____
 (En cas de suralimentation, voir également l'Article 334 sur fiche complémentaire)
 (In case of supercharging, see also Article 334 on complementary form)

305. Nombre et disposition des cylindres 4 in line
 Number and layout of the cylinders _____

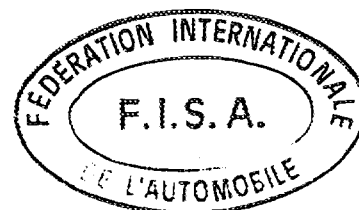
308. Mode de refroidissement liquid
 Cooling system _____

307. Cylindrée: a) Unitaire 498 cm³ b) totale 1993 cm³
 Cylinder capacity: a) Unitary _____ b) Total _____
 c) Totale maximum autorisée*: 1999,9 cm³ *(Cette indication n'est pas à considérer en Gr. N)
 c) Maximum total allowed*: _____ *(This indication is not to be considered in Gr. N)



Marque / Make: FORD Modèle / Model: RS2000 N° Homol.: B-214

312. Matériau du bloc-cylindres / Cylinder block material: Cast iron alloy
313. Chemises: a) /non c) Type: Sleeves: /no Type:
314. Alésage / Bore: 90,8 mm
315. Alésage maximum autorisé / Maximum bore allowed: 90,95 mm (Cette indication n'est pas à considérer en Cr N) (This indication is not to be considered in Gr N)
316. Course / Stroke: 76,9 mm
318. Bielle: a) Matériau / Material: Forged steel b) Type de la tête de bielle / Big end type: Split housing
- c) Diamètre intérieur de la tête de bielle (sans coussinets) / Interior diameter of the big end (without bearings): 55,0 mm ± 0.1%
- d) Longueur entre axes / Length between the axes: 127 mm (± 0.1 mm)
- e) Poids minimum / Minimum weight: 660 g
319. vilebrequin: a) Type de construction / Type of manufacture: One piece
- b) Matériau / Material: Cast iron alloy
- c) coulé / moulded estampe / stamped d) Nombre de paliers / Number of bearings: 5
- e) Type de paliers / Type of bearings: Plain bearings
- f) Diamètre des paliers / Diameter of bearings: 57,0 mm ± 0.2%
- g) Matériau des chapeaux des paliers / Bearing caps material: Cast iron alloy
- h) Poids minimum du vilebrequin nu / Minimum weight of the bare crankshaft: 12,100 g
320. Volant moteur: a) Matériau / Material: Cast iron alloy
- b) Poids minimum avec couronne de démarreur / Minimum weight of the flywheel with starter ring: 7,620 g
321. Culasse: a) Nombre de culasses / Number of cylinderheads: 1 b) Matériau / Material: Cast iron alloy
323. Alimentation par carburateur(s): a) Nombre de carburateurs / Number of carburetors: 2
- b) Type / Type: Double barrel c) Marque et modèle / Make and model: Weber 44 IDF



Marque / Make: FORD Modèle / Model: RS2000 N° Homol.: B-214

d) Nombre de passages de gaz par carburateur
Number of mixture passages per carburettor 2

e) Diamètre maximum de la tubulure de gaz à la sortie du carburateur
Maximum diameter of the flange hole of the carburettor exit port 44 mm

f) Diamètre du diffuseur au point d'étranglement maximum
Diameter of the venturi at the narrowest point 34 mm

24. Alimentation par injection:

Fuel feed by injection:

a) Marque: _____
Manufacturer: _____

b) Modèle du système d'injection:
Model of injection system: _____

c) Mode de dosage du carburant: mécanique électronique hydraulique
Kind of fuel measurement: mechanical electronical hydraulical

c1) Plongeur oui/non c2) Mesure du volume d'air oui/non
Piston pump yes/no Measurement of air volume yes/no

c3) Mesure de la masse d'air oui/non c4) Mesure de la vitesse de l'air oui/non
Measurement of air mass yes/no Measurement of air speed yes/no

c5) Mesure de la pression d'air oui/non Quelle est la pression de réglage?
Measurement of air pressure yes/no Which pressure is taken for measurement? _____ bars

d) Dimensions effectives du point de mesure au(x) papillon(s) ou au(x) tiroir(s) d'étranglement
Effective dimensions of measure position in the throttle area _____ mm

e) Nombre des sorties effectives de carburant
Number of effective fuel outlets _____

f) Position des soupapes d'injection: Canal d'admission Culasse
Position of injection valves: Inlet manifold Cylinderhead

g) Parties du système d'injection servant au dosage du carburant
Statement of fuel measuring parts of injection system _____

25. Arbre à cames: a) Nombre 1 b) Emplacement In cylinder head
Camshaft: Number Location

c) Système d'entraînement Notched belt d) Nombre de paliers par arbre 3
Driving system Number of bearings for each shaft

f) Système de commande des soupapes Oscillating lever
Type of valve operation

26. Distribution: e) Levée maximum des soupapes Admission Echappement
Timing: Maximum valve lift Inlet Exhaust

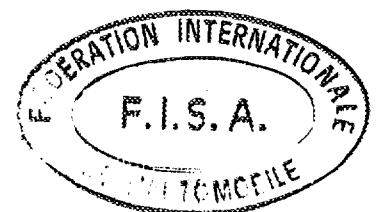
avec jeu de 11,8 mm 11,8 mm
with clearance 0,38 mm 0,38 mm

27. Admission: a) Matériau du collecteur Aluminium alloy
Inlet: Material of the manifold

b) Nombre d'éléments du collecteur 1 c) Nombre de soupapes par cylindre 1
Number of manifold elements Number of valves per cylinder

d) Diamètre maximum des soupapes 42,5 mm e) Diamètre de la tige de soupape 8 mm
Maximum diameter of the valves Diameter of the valve stem

f) Longueur de la soupape 112 + 2 mm g) Type des ressorts de soupape Coil
Length of the valve Type of valve springs



Marque FORD Modèle RS2000 N° Homol. B-214
Make _____ Model _____

328. Echappement: a) Matériau du collecteur Cast iron alloy
Exhaust: Material of the manifold _____
b) Nombre d'éléments du collecteur 1
Number of manifold elements _____
e) Diamètre maximum des soupapes 36,2 mm
Maximum diameter of the valves _____ mm
g) Longueur de la soupape 116 + 2 mm
Length of the valve _____ mm
d) Nombre de soupapes par cylindre 1
Number of valves per cylinder _____
f) Diamètre de la tige de soupape 8 mm
Diameter of the valve stem _____ mm
h) Type des ressorts de soupape Coil
Type of valve springs _____

330. Système d'allumage: a) Type Battery operated
Ignition system: Type _____
b) Nombre de bougies par cylindre 1
Number of plugs per cylinder _____
c) Nombre de distributeurs 1
Number of distributors _____
333. Système de lubrification: a) Type Compartmented
Lubrification system: Type Wet sump
b) Nombre de pompes à huile 1
Number of oil pumps _____

4. CIRCUIT DE CARBURANT / FUEL CIRCUIT

401. Réservoir: a) Nombre 1
Fuel tank: Number _____
c) Matériau Mild steel, treated
Material _____
b) Emplacement In rear compartment
Location _____
d) Capacité maximum 41 L
Maximum capacity _____

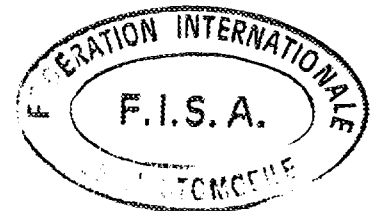
5. EQUIPEMENT ELECTRIQUE / ELECTRICAL EQUIPEMENT

501. Batterie(s): a) Nombre 1
Battery(ies): Number _____

6. TRANSMISSION / DRIVE

601. Roues motrices: avant arrière
Driving wheels: front rear

602. Embrayage: b) Système de commande Cable release (mechanical)
Clutch: Drive system _____
c) Nombre de disques 1
Number of plates _____



Marque / Make: **FORD** Modèle / Model: **RS2000** N° Homol.: **B-214**

603. Boite de vitesses: a) Emplacement / Location: **Behind engine**
 Gear-box:

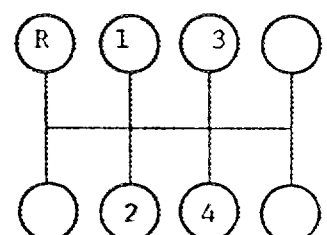
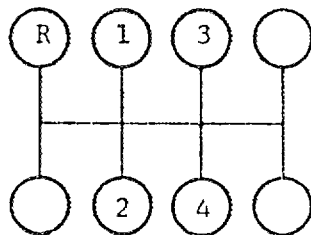
b) Marque «manuelle» / «Manual» make: **Ford** c) Marque «automatique» / «Automatic» make:

d) Emplacement de la commande / Location of the gear lever: **Central on floor**

e) Rappports / Ratios

	Manuelle / Manual			Automatique / Automatic			B.V. suppl. / Additional G.B.		
	rappports ratio	nombre de dents / number of teeth	synchro.	rappports ratio	nombre de dents / number of teeth	synchro.	rappports ratio	nombre de dents / number of teeth	synchro.
1	3,65	$\frac{29}{15}$	X				2,54	$\frac{27}{17}$	X
2	1,97	$\frac{25}{24}$	X				1,66	$\frac{25}{24}$	X
3	1,37	$\frac{21}{29}$	X				1,255	$\frac{25}{24}$	X
4	1,00	Direct	X				1,00	Direct	X
5									
AR/R	3,66	$\frac{31}{16}$					3,1	$\frac{31}{16}$	
Constante		$\frac{34}{18}$						$\frac{32}{20}$	
Constant.									

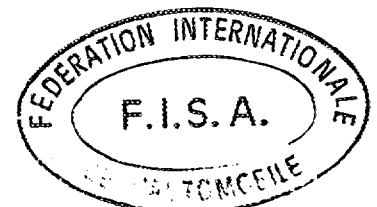
f) Grille de vitesse / Gear change gate



604. Surmultiplication: a) Type / Type: **N.A.**
 Overdrive:

b) Rapport / Ratio: **N.A.** c) Nombre de dents / Number of teeth: **N.A.**

d) Utilisable avec les vitesses suivantes / Usuable with the following gears: **N.A.**



Marque Make FORD Modéle Model RS2000 N° Homol. B-214

605. Couple final:

Final drive:

- a) Type du couple final
Type of final drive
- b) Rapport
Ratio
- c) Nombre de dents
Teeth number
- d) Type de limitation de différentiel (s) prévu
Type of differential limitation (if provided)

AV / Front	AR / Rear
	Hypoid
	3,56
	32:9

e) Rapport de la boîte de transfert
Ratio of the transfer box N.A.

606. Type de l'arbre de transmission
 Type of the transmission shaft 2 piece with hooks & sliding joints

7. SUSPENSION / SUSPENSION

701. Type de suspension: a) AV / Front MacPherson Strut + Independent
 Type of suspension: b) AR / rear Rigid axle - leaf springs + radius rods

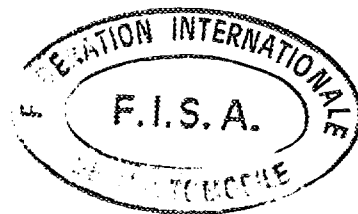
702. Ressorts hélicoïdaux: AV: oui/
 Helicoidal springs: Front: yes/ AR: /non
 Rear: /no

703. Ressorts à lames: AV: /non
 Leaf springs: Front: /no AR: oui/
 Rear: yes/

704. Barre de torsion: AV: /non
 Torsion bar: Front: /no AR: non
 Rear: /no

705. Autre type de suspension: Voir photo/dessin en page 15
 Other type of suspension: See photo or drawing on page 15

N.A.



Marque FORD Modèle RS2000 N° Homol. B-214
 Make _____ Model _____

707. Amortisseurs:

Shock Absorbers:

- a) Nombre par roue
 Number per wheel
 b) Type
 Type
 c) Principe de fonctionnement
 Working principle

Avant / Front	Arrière / Rear
1	1
Telescopic	Telescopic
Hydraulic	Hydraulic

8. TRAIN ROULANT / RUNNING GEAR:

801. Roues: a) Diamètre AV 13 " / 330 mm AR 13 " / 330 mm
Wheels: Diameter Front _____ " / _____ mm Rear _____ " / _____ mm

803. Freins: a) Système de freinage Hydraulic
Brakes: Braking system _____
 b) Nombre de maître-cylindres Tandem b1) Alésage 2 x 20,6 mm
 Number of master cylinders _____ Bore _____ mm
 c) Servo-frein oui/ c1) Marque et type Ford Vacuum
 Power assisted brakes yes/ Make and type _____
 d) Régulateur de freinage oui/ d1) Emplacement Near rear axle
 Braking adjuster yes/ Location _____

e) Nombre de cylindres par roue:
 Number of cylinders per wheel:

e1) Alésage
 Bore

f) Freins à tambours:
 Drum brakes:

f1) Diamètre intérieur
 Interior diameter

f2) Nombre de mâchoires par roue.
 Number of shoes per wheel

f3) Surface de freinage
 Braking surface

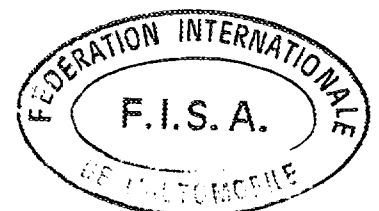
f4) Largeur des garnitures
 Width of the shoes

g) Freins à disques:
 Disc brakes:

g1) Nombres de sabots par roue
 Number of pads per wheel

g2) Nombre d'étriers par roue
 Number of calipers per wheel

Avant / Front	Arrière / Rear
2	1
54 mm	19,05 mm
_____ mm (± 1,5 mm)	228,6 mm (± 1,5 mm)
_____	2
_____ cm ²	319,5 cm ²
_____ mm	44,5 mm
2	_____
1	_____



Marque FORD
 Make _____

Modèle RS2000
 Model _____

N° Homol. B-214

	AV / Front	AR / Rear
g3) Matériau des étriers Caliper material	Cast iron	
g4) Epaisseur maximale du disque Maximum disc thickness	12,8 mm	_____ mm
g5) Diamètre extérieur du disque Exterior diameter of the disc	247,5 mm (± 1 mm)	_____ mm (± 1 mm)
g6) Diamètre extérieur de frottement des sabots Exterior diameter of the shoe's rubbing surface	245 mm	_____ mm
g7) Diamètre intérieur de frottement des sabots Interior diameter of the shoe's rubbing surface	139,8 mm	_____ mm
g8) Longueur hors-tout des sabots Overall length of the shoes	76,6 mm	_____ mm
g9) Disques ventilés Ventilated disc	/non /no	oui/non yes/no
g10) Surface de freinage par roue Braking surface per wheel	655,2 cm²	_____ cm²

h) Frein de stationnement:
 Parking brake: _____
 h2) Emplacement de la commande
 Location of the lever Central on floor

h1) Système de commande
 Command system Lever + cable
 h3) Effet sur roues
 On which wheels AV Front AR Rear Rear

804. Direction: a) Type Rack & pinion
 Steering: Type _____
 b) Rapport 18:1
 Ratio _____

c) Servo-assistance /non
 Power assisted /no

9. CARROSSERIE / BODYWORK

901. Intérieur: a) Ventilation oui/
 Interior: Ventilation yes/
 f) Toit ouvrant optionnel oui/
 Sun roof optional yes/

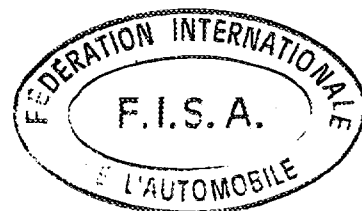
b) Chauffage oui/
 Heating yes/
 f1) Type Steel sliding

f2) Système de commande
 Command system Rotating handle

g) Système d'ouverture des vitres latérales:
 Opening system for the side windows: AV/Front: Rotating handle
 AR/Rear: Rotating handle

902. Extérieur: a) Nombre de portes 2
 Exterior: Number of doors _____

b) Hayon AR non
 Rear tailgate /no Mild steel sheet
 c) Matériau des portières:
 Door material: AV/Front: _____
 AR/Rear: N.A.



Marque FORD Modéle RS 2000 N° Homol. B-214
 Make _____ Model _____

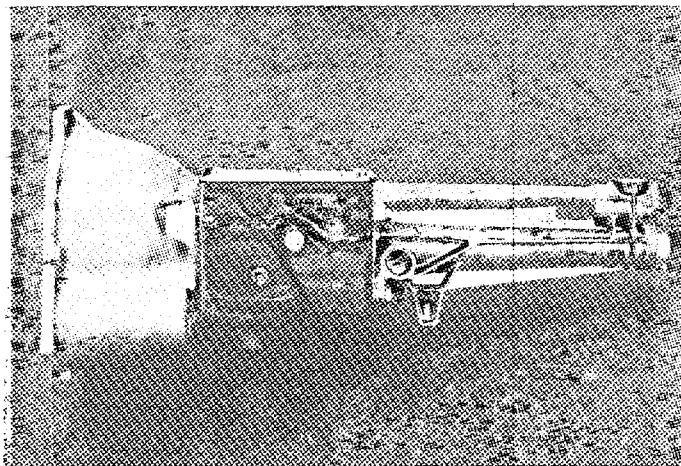
d) Matériau du capot AV Front bonnet material	Mild steel sheet pressing
e) Matériau du capot/hayon AR Rear bonnet / tailgate material	Mild steel sheet pressing
f) Matériau de la carrosserie Bodywork material	Mild steel sheet pressing
g) Matériau du pare-brise Windscreen material	Laminated glass only for competition use
h) Matériau de la lunette AR Rear window material	Safety glass
i) Matériau des glaces de custode Rear quarter lights material	Safety glass
k) Matériau des vitres latérales Side window material	AV / Front Safety glass AR / Rear Safety glass
l) Matériau du pare-choc avant Material of the front bumper	Mild steel/plastic
m) Matériau du pare-choc arrière Material of the rear bumper	Mild steel

INFORMATIONS COMPLEMENTAIRES

COMPLEMENTARY INFORMATION

Alternative final drives 4,11 = 9 : 37
 (Art. 605) 4,63 = 8 : 37

Photo : Alternative manual gear box



Marque
Make

FORD

Modèle
Model

RS2000

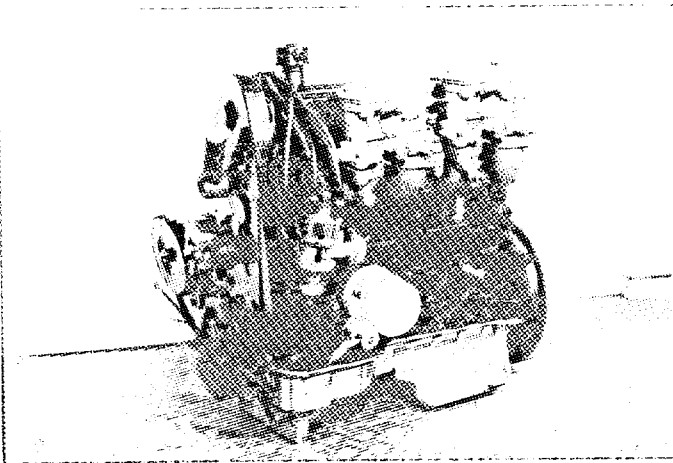
N° Homol.

B-214

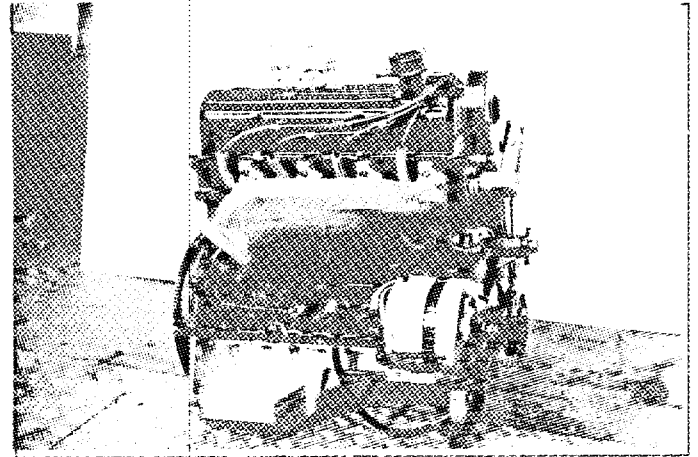
PHOTOS / PHOTOS

Moteur / Engine

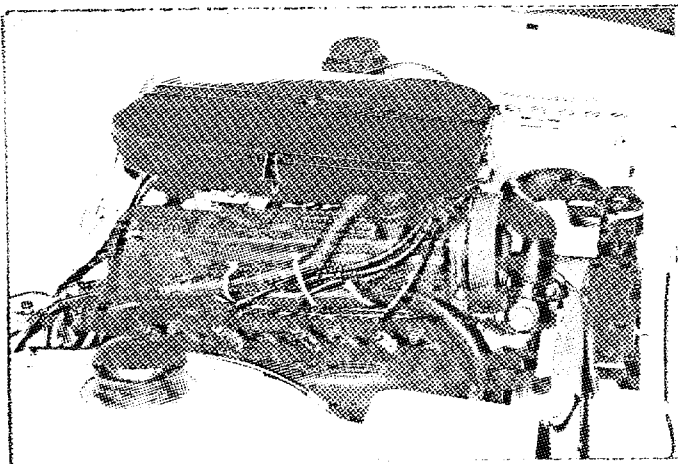
C) Profil droit du moteur déposé
Right hand view of dismantled engine



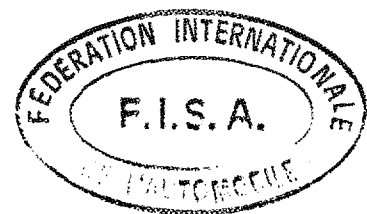
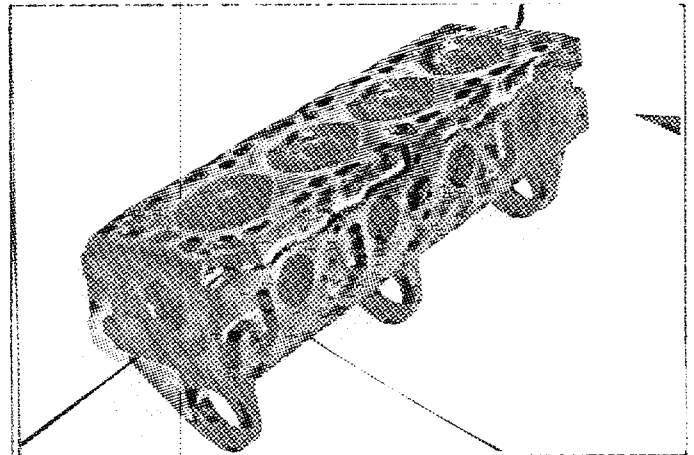
D) Profil gauche du moteur déposé
Left hand view of dismantled engine



E) Moteur dans son compartiment
Engine in its compartment



F) Culasse nue
Bare cylinderhead



Marque
Make

FORD

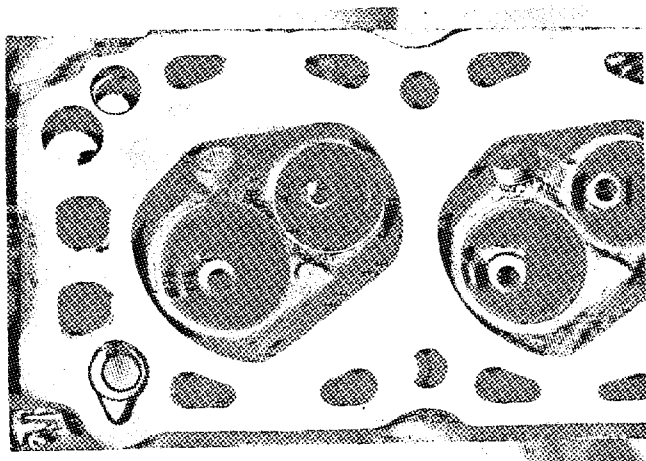
Modèle
Model

RS2000

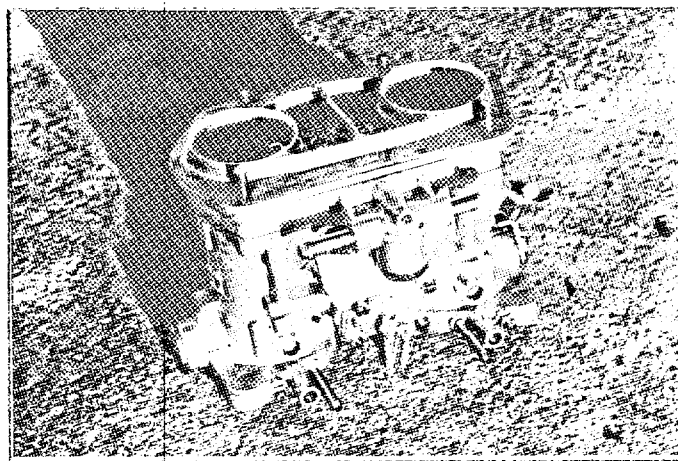
N° Homol

B-214

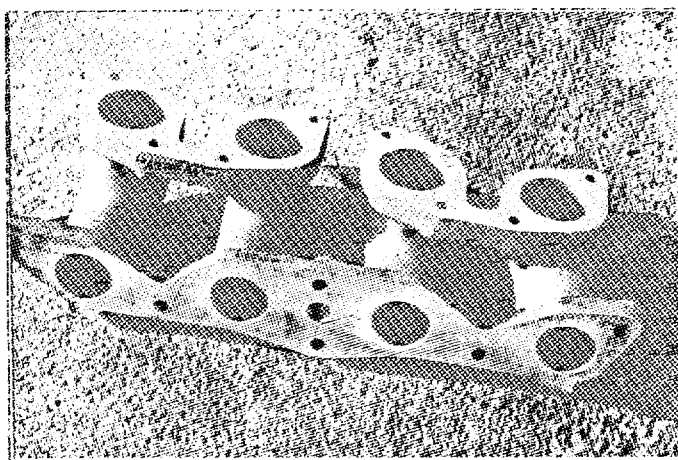
G) Chambre de combustion
Combustion chamber



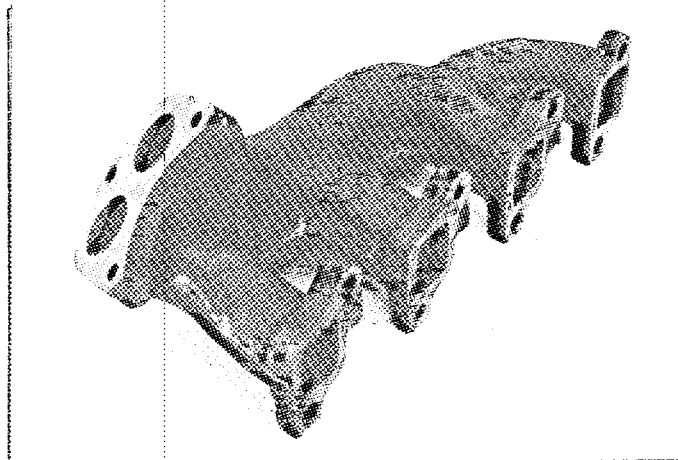
H) Carburateur(s) ou système d'injection
Carburetor(s) or injection system



I) Collecteur d'admission
Inlet manifold

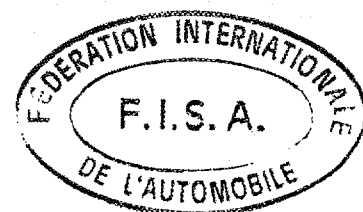
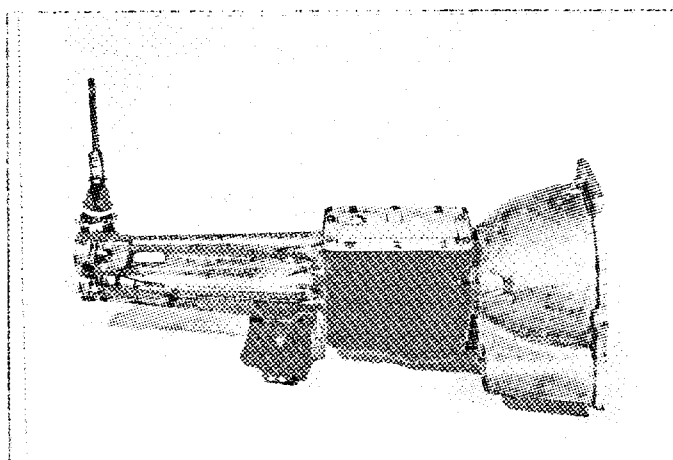


J) Collecteur d'échappement
Exhaust manifold



Transmission / Transmission

S) Carter de boîte de vitesse et cloche d'embrayage
Gearbox casing and clutch bellhousing



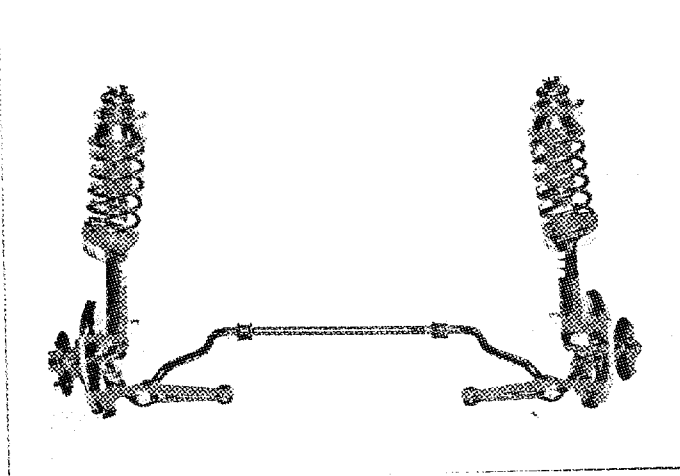
Marque FORD
Make

Modèle RS 2000
Model

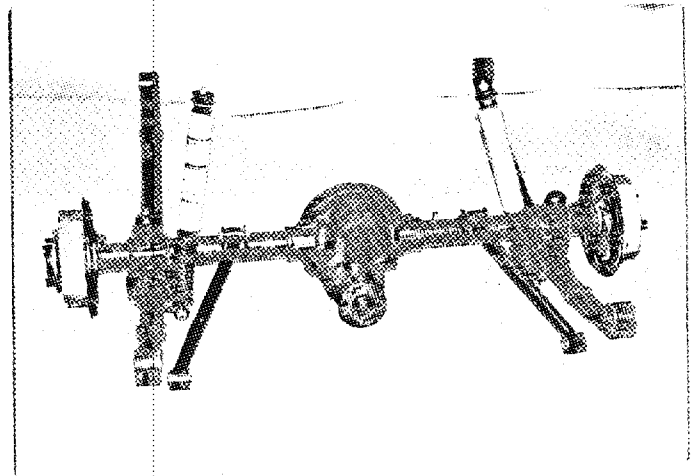
N° Homol. B-214

Suspension / Suspension

T) Train avant complet déposé
Complete dismantled front running gear

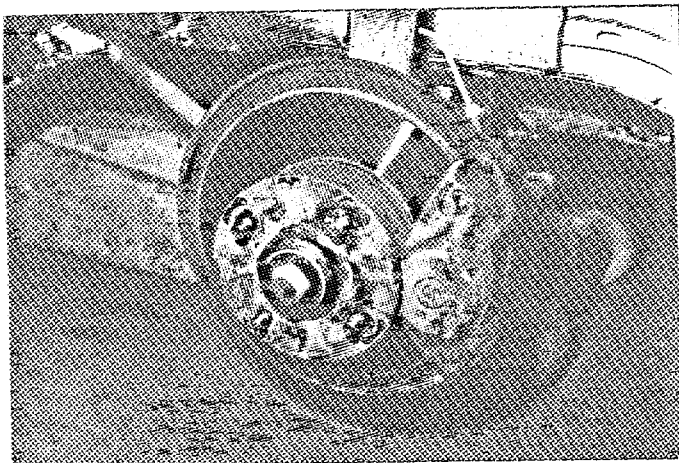


U) Train arrière complet déposé
Complete dismantled rear running gear

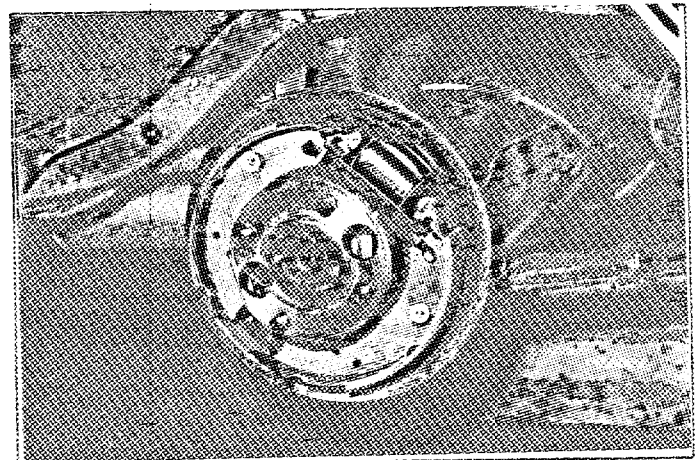


Train roulant / Running gear

V) Freins avant
Front brakes

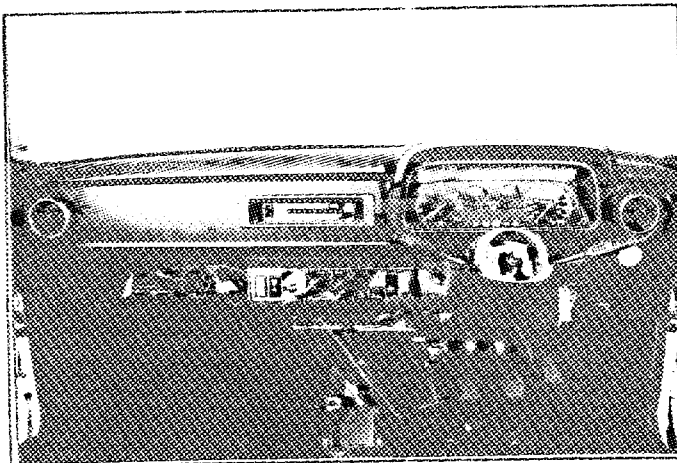


W) Freins arrière
Rear brakes

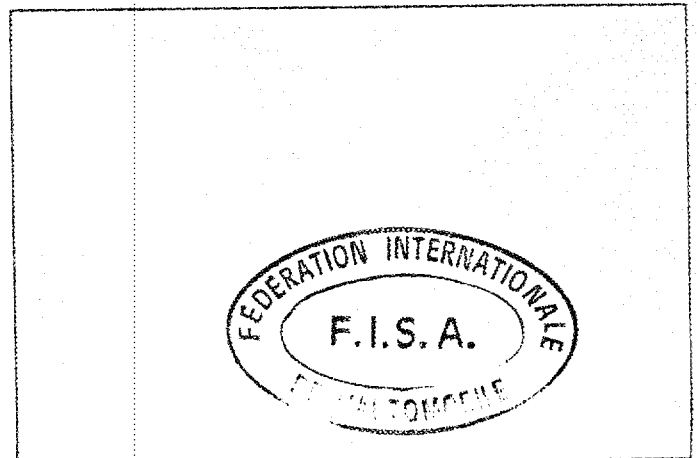


Carrosserie / Bodywork

X) Tableau de bord
Dashboard



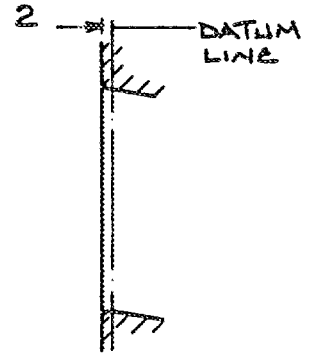
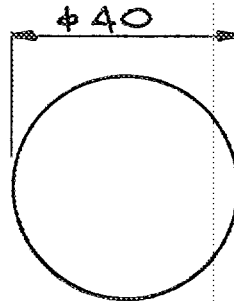
Y) Toit ouvrant
Sunroof



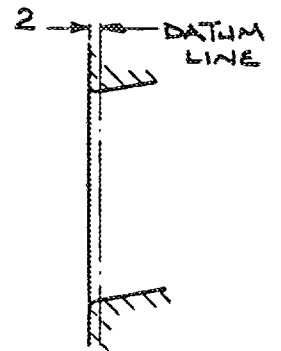
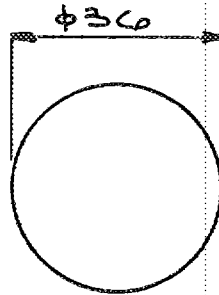
DESSINS / DRAWINGS

Moteur / Engine

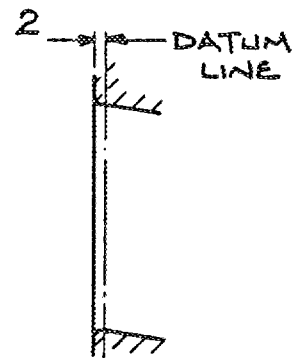
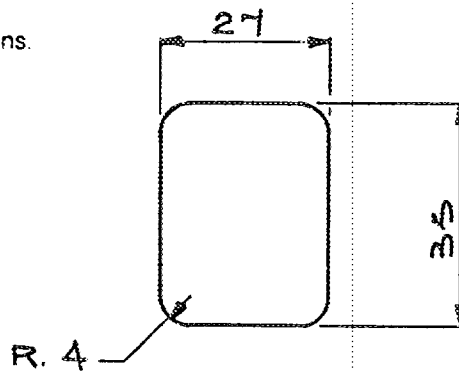
- I Orifices d'admission de la culasse, face collecteur (tolérances sur dimensions: -2%, +4%)
Cylinderhead inlet ports, manifold side (tolerances on dimensions: -2%, +4%)



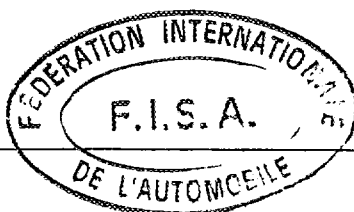
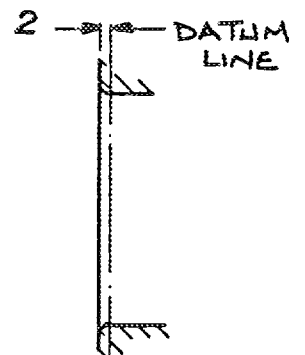
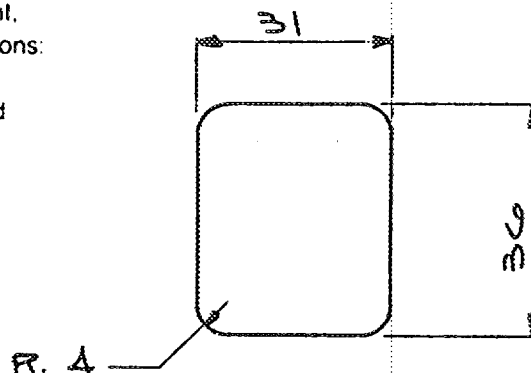
- II Orifices du collecteur d'admission, côté culasse (tolérances sur dimensions: -2%, +4%)
Inlet manifold ports, cylinderhead side (tolerances on dimensions: -2%, +4%)



- III Orifices d'échappement de la culasse, face collecteur (tolérances sur dimensions: -2%, +4%)
Cylinderhead exhaust ports, manifold side (tolerances on dimensions: -2%, +4%)



- IV Orifices du collecteur d'échappement, côté culasse (tolérances sur dimensions: -2%, +4%)
Exhaust manifold ports, cylinderhead side (tolerances on dimensions: -2%, +4%)



Marque
Make

FORD

Modèle
Model

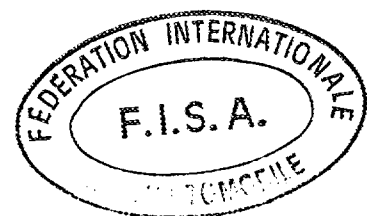
RS2000

N° Homol.

B - 214 3

Suspension / Suspension

- XV Système de suspension, selon l'article 705 ou en remplacement des photos O et P.
Suspension system according to article 705 or replacing photos O and P.

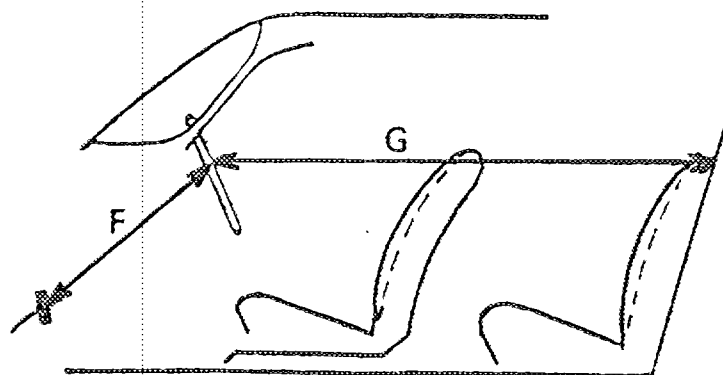
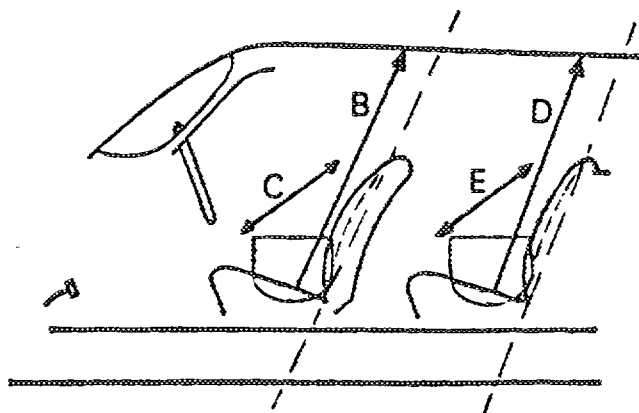




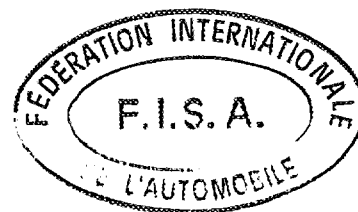
FEDERATION INTERNATIONALE DU SPORT AUTOMOBILE

Homologation N°

B - 2 1 4

Groupe **A/B**
GroupMarque FORD Modèle RS2000
Make FORD Model RS2000Dimensions intérieures comme définies par le Règlement d'Homologation
Interior dimensions as defined by the Homologation Regulations.

B (Hauteur sur sièges avant) (Height above front seats)	1000	mm
C (Largeur aux sièges avant) (Width at front seats)	1270	mm
D (Hauteur sur sièges arrière) (Height above rear seats)	920	mm
E (Largeur aux sièges arrière) (Width at rear seats)	1275	mm
F (Volant – Pédale de frein) (Steering wheel – brake pedal)	620	mm
G (Volant – paroi de séparation arrière) (Steering wheel – rear bulkhead)	1490	mm
H = F+G =	2110	mm





FEDERATION INTERNATIONALE DU SPORT AUTOMOBILE

Homologation N°

B - 2 1 4

Extension N°

01 / 01 VF

FICHE D'EXTENSION A L'HOMOLOGATION OFFICIELLE FISA FORM OF EXTENSION TO THE OFFICIAL FISA HOMOLOGATION

ET Evolution normale du type: dès le numéro de châssis
Normal evolution of the type: as from chassis number

VF Variante de fourniture / Supply variant

VO Variante option / Option variant

ER Errata / Erratum

Homologation valable dès le _____
Homologation valid as from -1 JAN 1982

en groupe

in group

Constructeur

FORD

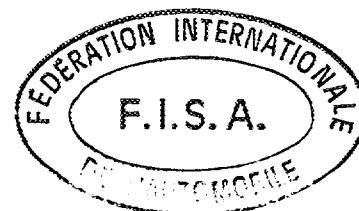
Modèle et type

Escort 2 litre

Manufacturer

Model and type

Page ou ext Page or ext.	Art. Art.	Description Description
	313	Dry, cast iron liners are a factory reclaim procedure - the customer having no option.
	327e & 328f	Valve stem oversize at 8,2 and 3,4 mm are factory reclaim - the customer having no option.





FEDERATION INTERNATIONALE DU SPORT AUTOMOBILE

Homologation N°

B-214

Extension N°

02/0190

FICHE D'EXTENSION A L'HOMOLOGATION OFFICIELLE FISA FORM OF EXTENSION TO THE OFFICIAL FISA HOMOLOGATION

ET Evolution normale du type: dès le numéro de châssis
Normal evolution of the type: as from chassis number

VF Variante de fourniture / Supply variant

VO Variante option / Option variant

ER Errata / Erratum

Homologation valable dès le
Homologation valid as from

-1 JUN 1962

en groupe
in group

Constructeur
Manufacturer

FORD

Modèle et type
Model and type

Escort 2 litre

Page ou ext
Page or ext.

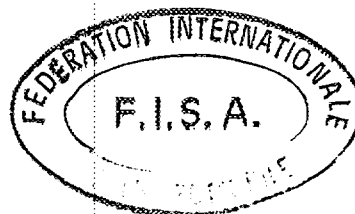
Art.
Art.

Description
Description

7

701

Combined radius rods and anti roll bar - see
photo 81-3



Marque
Make

FORD

Modèle
Model

Escort 2 litre

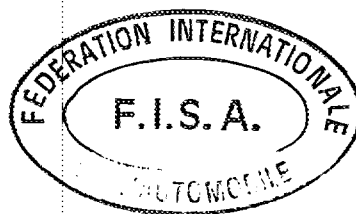
N° Homol.

B-214

V0

N° Ext. 02 / 01 V0

Page ou ext. Page or ext.	Art. Art.	Description Description
	707	Heavy duty hub - alum alloy complete with increased capacity bearings - see photo 81-4
8	707	Reinforced suspension element incorporating increased damper capacity - Body O.D. = 51 mm See photo 81-5
7	701	Reinforced front suspension mount (4 bolt clamp) See photo 81-6
7	701	Reinforced front suspension incorporating redesigned tie bars and anti roll bars. Kinematics unaltered. See photo 81-7
7	606	One piece engine to axle drive shaft using needle rollers and sliding spline. See photo 81-8
7	606b	Two piece half shaft + increased bearing capacity See photo 81-9
8	803	Disc brake rear axle conversion incorporating heavy duty bearing, carrier and hub assembly. See photo 81-10
8	803b1	Dual circuit brake box Cylinder sizes may be 15,87; 17,78; 19,05; 20,6 mm dia. Brake fluid resrvoir is not inside habitacle See photo 81-11
8	803c	Brake boost - fitted in line, is optional
8	803 c1	Vacuum assist.
9	804	Quick ratio steering Ratio = 14:1



Marque
Make

FORD

Modèle
Model

Escort 2 litre

N° Homol.

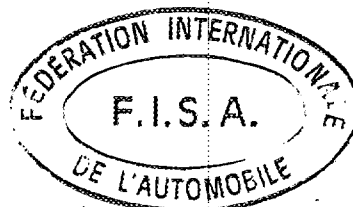
B-214

VO

N° Ext

02 / 01 VO

Page ou ext. Page or ext.	Art. Art.	Description Description		
		Alternative brakes		
		<u>Front</u>		
8	803e	4	803e1	38,1
8	803g1	2	803g2	1
9	803g3	Aluminium alloy Shown on photo 81-12	803g8	112 mm
	803g4	20,7 mm	803g5	264 mm
9	803g6	262 mm	803g7	160 mm
	803g10	672,3 cm ² Shown on photo 81-12	803g9	Ventilated
		<u>Rear</u>		
8	803e	2	803e1	38 mm
8	803g1	2	803g2	1
9	803g3	Cast iron	803g8	62 mm
			See photo 81-13	
		For use with vented and non vented disc		
8	803e	2	803e1	51 mm
8	803g1	2	803g2	1
9	803g3	Aluminium alloy	803g8	75 mm
			See photo 81-14	
		For use with vented and non vented disc		
9	803g4	13 mm	803g5	265 mm
	803g6	263 mm	803g7	156 mm
	803g10	704,2 cm ²	803g9	Non ventilated
			See photo 81-15	
9	803g4	20,7 mm	803g5	264 mm
	803g6	262 mm	803g7	160 mm
	803g10	676,1 cm ²	803g9	Ventilated
			See photo 81-16	
		Alternative brakes		
		<u>Front</u>		
	803e	2	803e1	54 mm
	803g1	2	803g2	1
	803g3	Cast iron	803g8	77 mm
	803g4	20 mm	803g5	244 mm
	803g6	243 mm	803g7	136 mm
	803g10	637,0 cm ²	803g9	Ventilated
			See photo 81-21	



Marque
Make

FORD

Modèle
Model

Escort 2 litre

N° Homol.

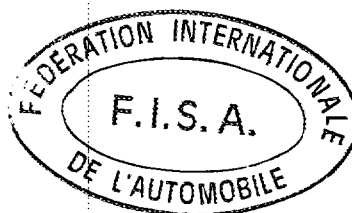
B-214

VO

N° Ext.

02 / 01 VO

Page ou ext. Page or ext.	Art. Art.	Description Description
		For improved handbrake the following kit is available: Master cylinder 17,8 or 19,1 mm bore
8	803g2	This increases number of calipers/wheel for rear axle to 2. See photo's 81-17 & 18
8	803e	2 803e1 57 mm
8	803g1	2 803g2 1
9	803g3	Aluminium alloy 803g8 75 mm
		Alternative main rear axle caliper when using hydraulic handbrake kit - see photo 81-19.



Marque
Make

FORD

Modèle
Model

RS 2000

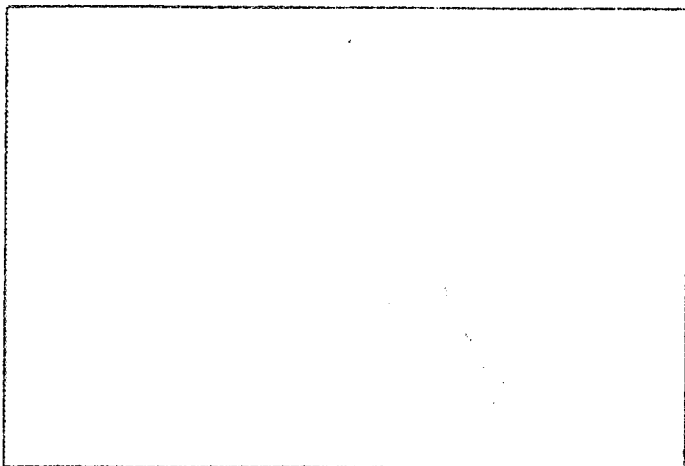
N° Homol.

B-214

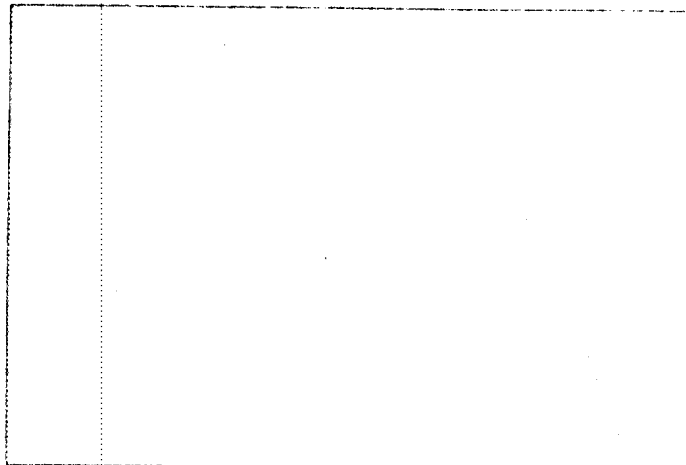
PHOTOS / PHOTOS

N° Ext.

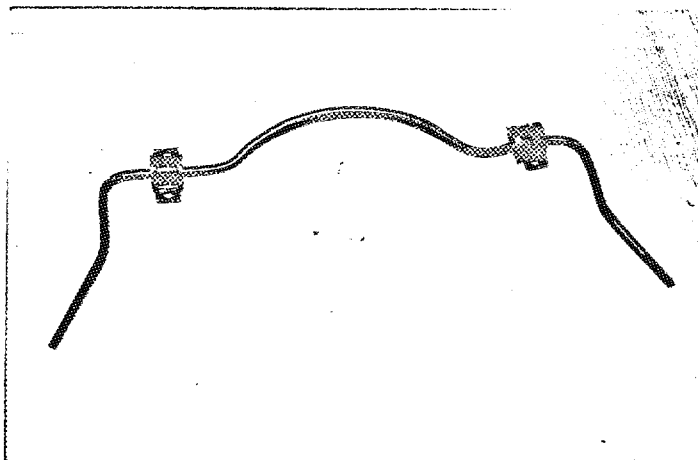
02 / 01 VO



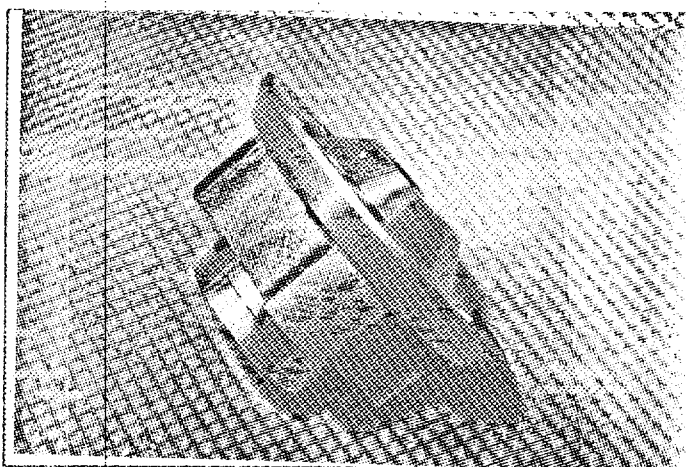
81-1



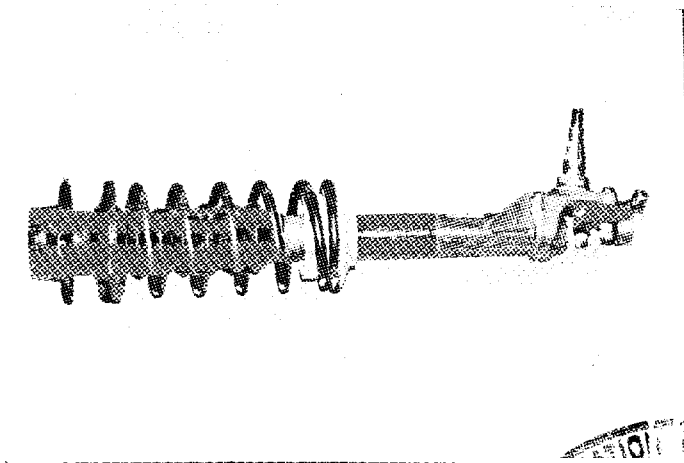
81-2



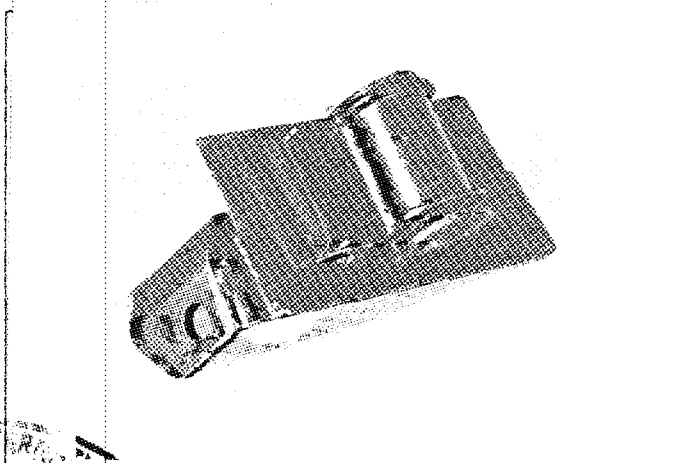
81-3



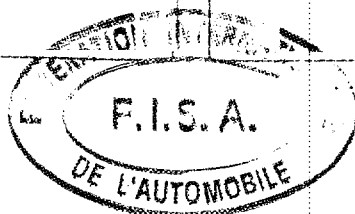
81-4



81-5



81-6



Marque
Make

FORD

Modèle
Model

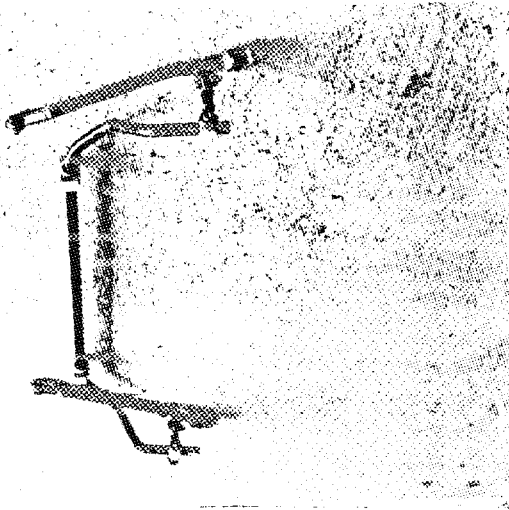
RS 2000

B-214

N° Homol

PHOTOS / PHOTOS

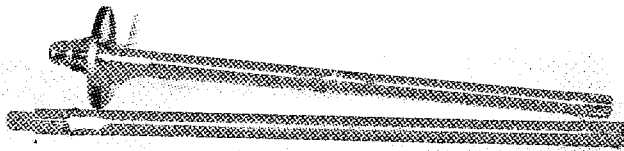
N° Ext 02 / 0 1 100



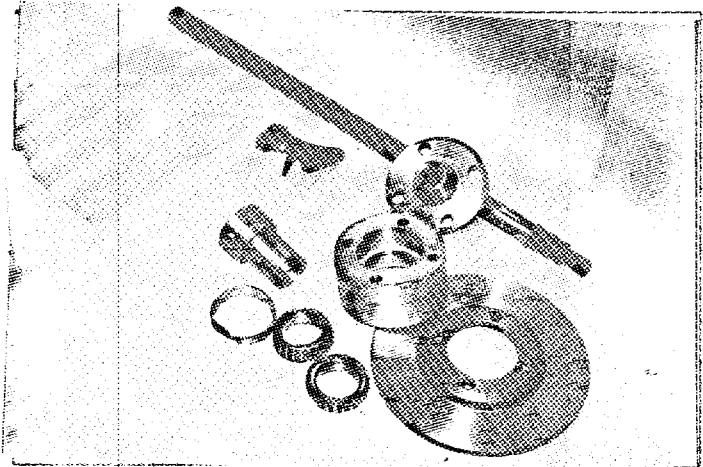
81-7



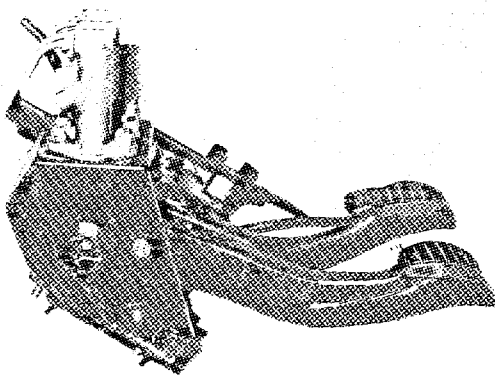
81-8



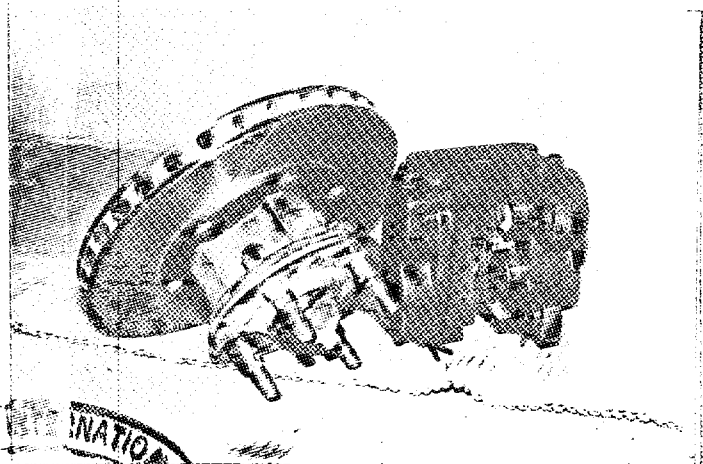
81-9



81-10



81-11



81-12



Marque
Make

FORD

Modèle
Model

RS 2000

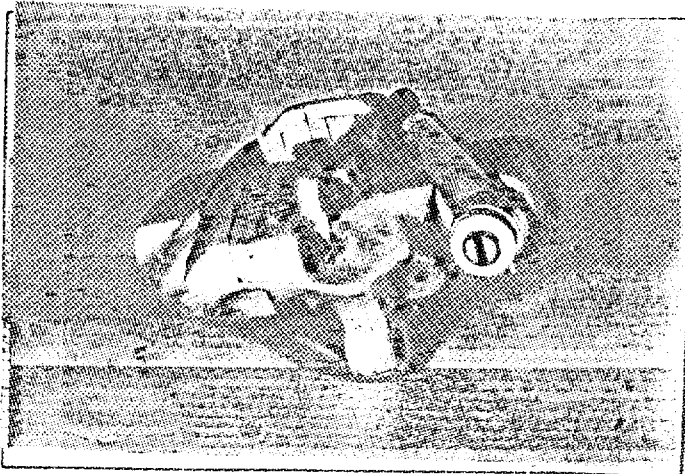
N° Homol.

0-214

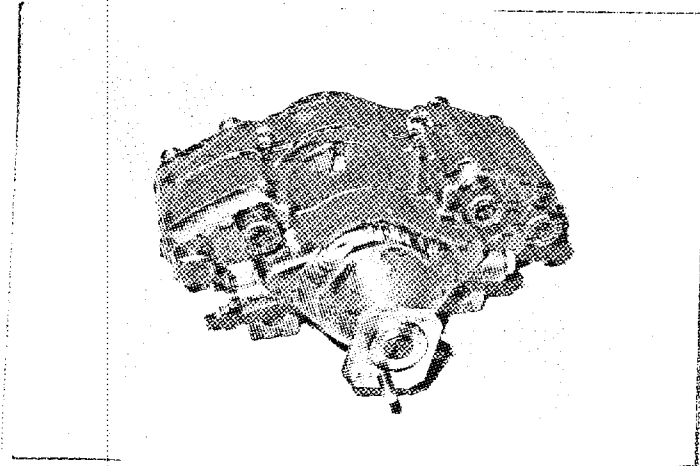
PHOTOS / PHOTOS

N° Ext.

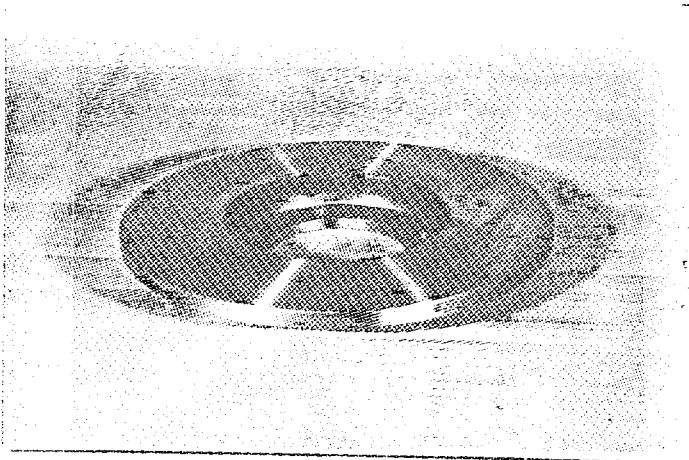
02 / 01V0



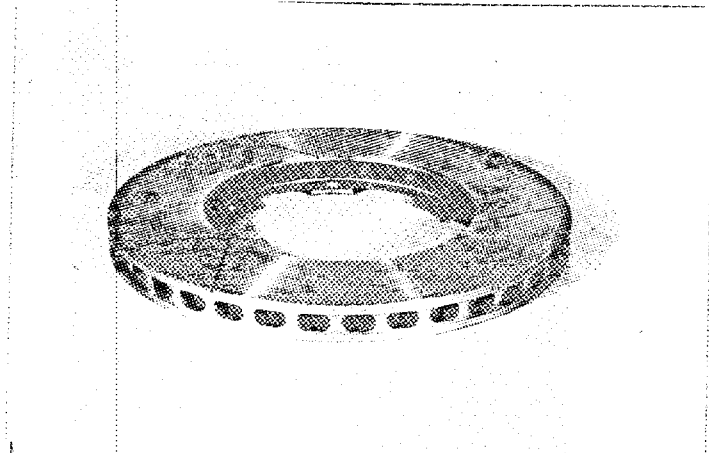
81-13



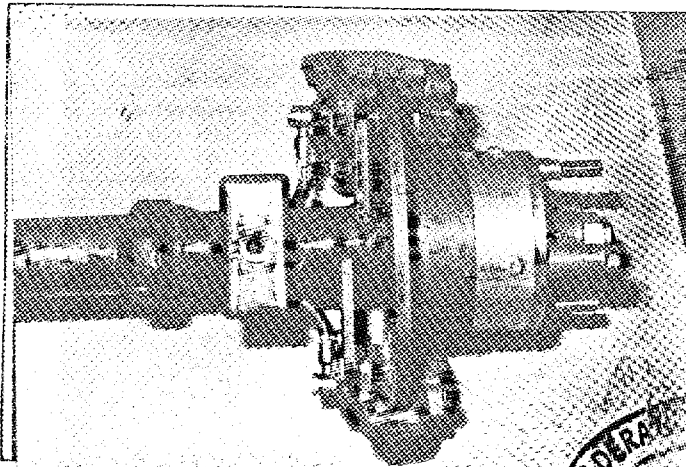
81-14



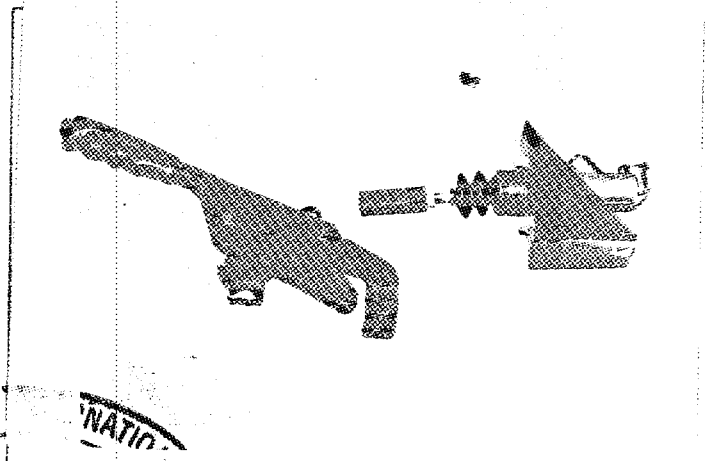
81-15



81-16



81-17



81-18



Marque
Make

FORD

Modèle
Model

RS 2000

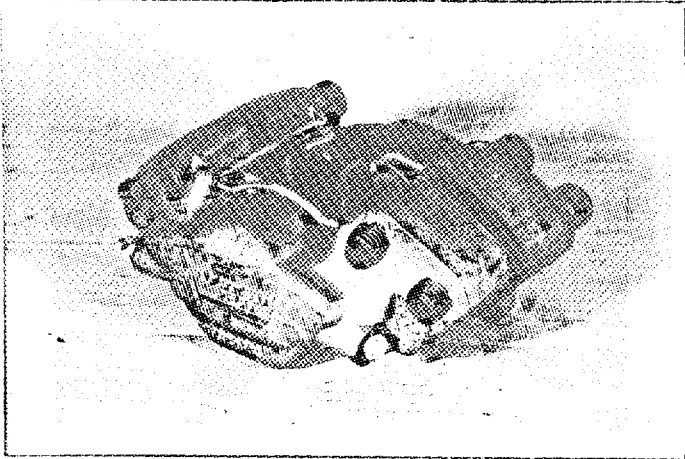
N° Homol

B-214

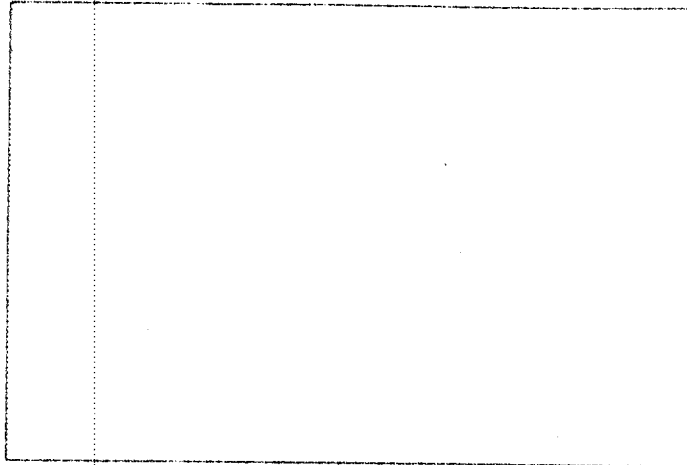
PHOTOS / PHOTOS

N° Ext.

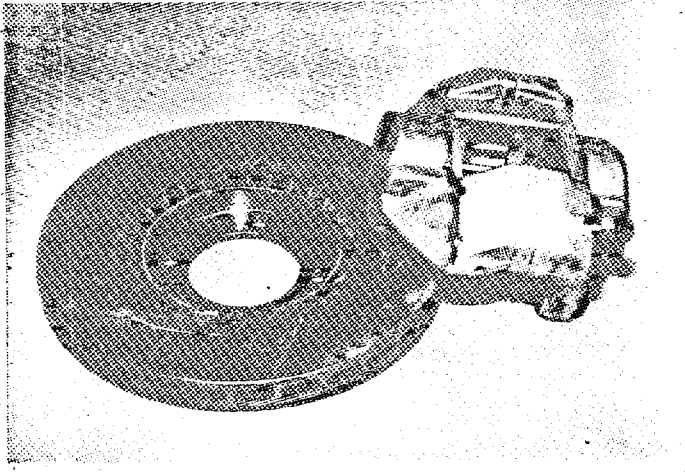
02 / 01 V0



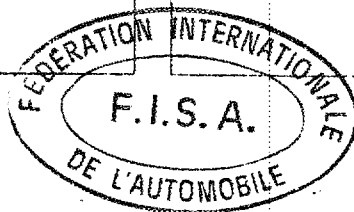
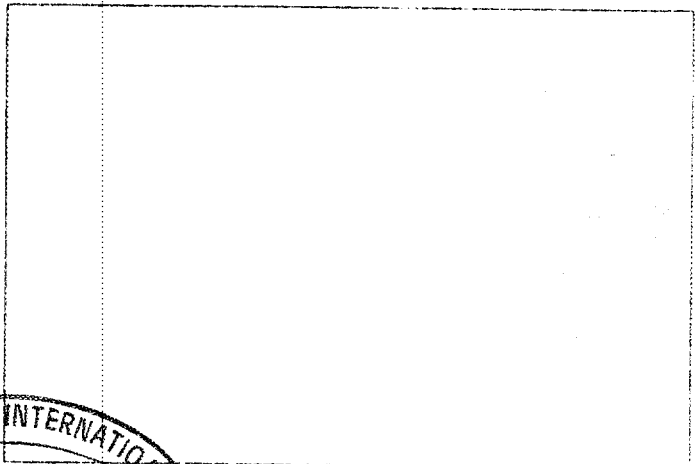
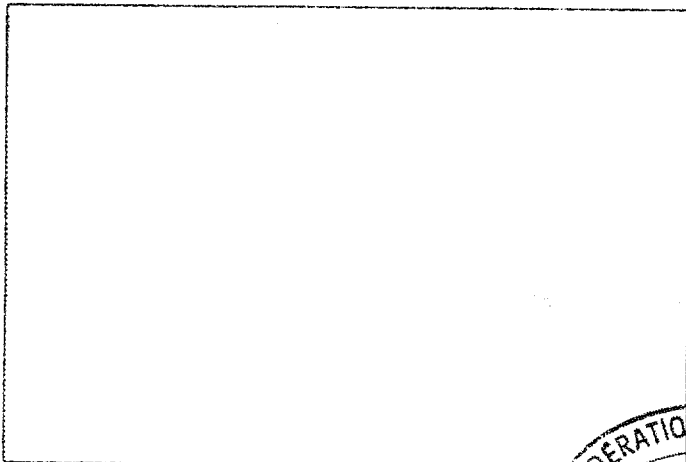
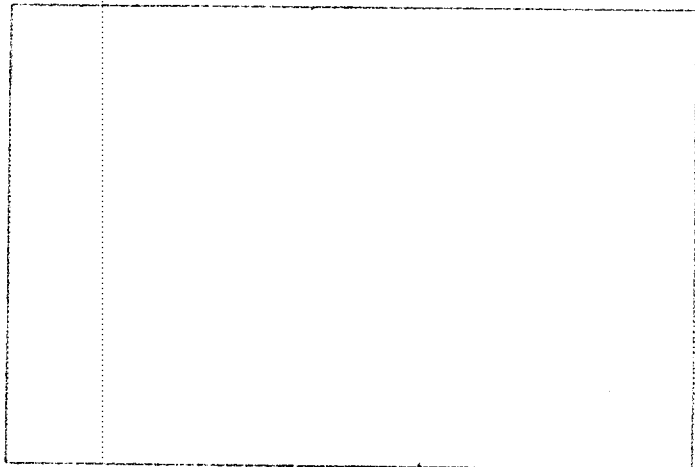
81-19



81-20



81-21





FEDERATION INTERNATIONALE DU SPORT AUTOMOBILE

Homologation N°

B 214

Extension N°

03 / 01 ER

FICHE D'EXTENSION A L'HOMOLOGATION OFFICIELLE FISA
FORM OF EXTENSION TO THE OFFICIAL FISA HOMOLOGATION

ET Evolution normale du type: dès le numéro de châssis
Normal evolution of the type as from chassis number _____

VF Variante de fourniture / Supply variant

VO Variante option / Option variant

ER Errata / Erratum

Homologation valable dès le _____ -1. JUL. 1982
Homologation valid as from _____

en groupe _____ B
in group _____

Constructeur _____ FORD
Manufacturer _____

Modèle et type _____ RS 2000 B
Model and type _____

Page ou ext Page or ext.	Art. Art.	Description Description
	327d	CORRECTION 44,5 mm dia.
	328e	INCORRECT DIMENSION 38,1 mm dia. 42.5 mm dia. 36.2 mm dia.





FEDERATION INTERNATIONALE DU SPORT AUTOMOBILE

Homologation N°

B - 214 -

Extension N°

04 / 02 ER

FICHE D'EXTENSION A L'HOMOLOGATION OFFICIELLE FISA
FORM OF EXTENSION TO THE OFFICIAL FISA HOMOLOGATION

- ET** Evolution normale du type: dès le numéro de châssis
Normal evolution of the type: as from chassis number _____
- VF** Variante de fourniture / Supply variant
- VO** Variante option / Option variant
- ER** Errata / Erratum

Homologation valable dès le _____ **- 1 OCT. 1983** _____ en groupe **B**
Homologation valid as from _____ in group _____

Constructeur **FORD** Modèle et type **escort 2000 RS**
Manufacturer _____ Model and type _____

Page ou ext. Page or ext.	Art. Art.	Description Description
------------------------------	--------------	----------------------------

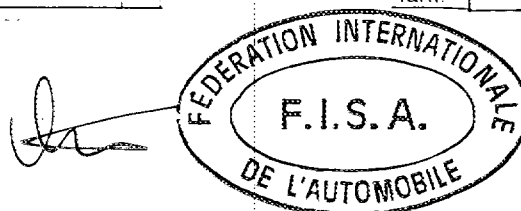
Page 6

603e

	B.V. suppl. / Additional G.B.		
	rappports ratio	nombre de dents/ number of teeth	synchro.
1			
2			
3	1,25	$\frac{22}{28}$	
4			
5			
AR/R			
Const- tante Const- tant.			

au lieu de :
instead of :

	B.V. suppl. / Additional G.B.		
	rappports ratio	nombre de dents/ number of teeth	synchro.
1			
2			
3	1,25	$\frac{25}{24}$	
4			
5			
AR/R			
Const- tante Const- tant.			





FEDERATION INTERNATIONALE DE L'AUTOMOBILE

FORD - ESCORT RS 2000

MARQUE ET MODELE

6/82

VALIDITE HOMOLOGATION

B 214

FICHE NR.

B / 2000

GROUPE / CLASSE

EXTENSIONS	DEBUT VALIDITE	DESCRIPTION	NOTES
01/01VF	6/82	CAMEISES - SOUPAPE -	
02/02VW	6/82	SUSPENSION - TRANSMISSION FREIN -	
03/01ER	6/82	SOUPAPE	
04/01ER	10/82	RAPPORT	

Autres homologations du modèle 5566 - 5566 TRANSFERT A
A 5035

Vérifiée le 24/01/95 par [signature] visée ce jour le _____ par _____